



# Guide for rescue workers

Information on responding to accidents involving  
Volkswagen vehicles with high-voltage powertrains



Stand: 03/2020



**Legal notice:**

This guide was created exclusively for emergency and recovery personnel who are specially trained in technical assistance after road accidents and can therefore carry out the activities described in it. Furthermore, the guide contains information about vehicles intended for sale in the European Union. It does not contain any information about vehicles intended for sale outside the European Union. The range of vehicles offered by Volkswagen AG, as well as their specifications and special equipment, are always subject to change. Volkswagen therefore explicitly reserves the right to modify or change the content of this guide at any time.

**Please note:**

The information contained in this guide is **not** intended for end customers, and is also **not** for workshops and dealerships.

End customers can find information on the functions of their Volkswagen AG vehicle, as well as important vehicle and passenger safety information, in the vehicle wallet. Workshops and dealerships receive repair information from their accustomed sources.

The information was up to date at the time it was written.

© Volkswagen AG

# Content

<b>Introduction</b> .....	<b>04</b>	<b>5</b>	<b>Stored energy / fluids / gases / solids</b> .....	<b>29</b>	
<b>0</b>	<b>Rescue card(s)</b> .....	<b>05</b>	Warning labels for high-voltage components .....	<b>30</b>	
<b>1</b>	<b>Identification / recognition</b> .....	<b>07</b>	<b>6</b>	<b>In case of fire</b> .....	<b>32</b>
	General distinguishing features of high-voltage vehicles .....	<b>08</b>	<b>7</b>	<b>In case of submersion</b> .....	<b>34</b>
	What does "high voltage" mean? .....	<b>10</b>	<b>8</b>	<b>Towing / transportation / storage</b> .....	<b>36</b>
	The high-voltage battery .....	<b>11</b>	<b>9</b>	<b>Important additional information</b> .....	<b>38</b>
	Battery concepts .....	<b>12</b>		Airbag .....	<b>39</b>
	High-voltage safety .....	<b>15</b>		Airbag gas generators .....	<b>45</b>
<b>2</b>	<b>Immobilisation / stabilisation / lifting</b> .....	<b>16</b>		Belt tensioners .....	<b>46</b>
	Stopping the vehicle from rolling away .....	<b>17</b>		Rollover bar .....	<b>51</b>
	Switching off the ignition .....	<b>18</b>		Active bonnet .....	<b>52</b>
	Lifting the vehicle .....	<b>18</b>	<b>10</b>	<b>Explanation of pictograms used</b> .....	<b>53</b>
<b>3</b>	<b>Disable direct hazards / safety regulations</b> .....	<b>19</b>			
	Cut-off points for disabling the high-voltage system .....	<b>20</b>			
	Disconnecting a charging station .....	<b>22</b>			
<b>4</b>	<b>Access to the occupants</b> .....	<b>24</b>			
	Body and materials .....	<b>25</b>			

## Introduction

The driver, the vehicle and the surroundings are the three key factors whose interaction is decisive for road safety.

The vehicle has a number of jobs to do when an accident occurs, including:

- Keeping the passenger compartment as rigid as possible to ensure a space for survival.
- Dissipating the vehicle energy using intelligent structural concepts and elements.
- Using an optimised restraint system – consisting of airbags and seat belts with tensioners and force limiters – to effectively protect the occupants.
- Using safety systems to minimise the hazards from service fluids and powertrain components.

Volkswagen vehicles have proven in international tests that they are among the safest. However, accidents and the associated injuries can never be ruled out. This means a short, fast and effective chain of rescue is as essential as ever.

This guide is intended to help emergency and recovery forces do their jobs by providing the necessary information on the technology used in Volkswagen vehicles.

Technical innovations such as new materials in addition to steel and aluminium in body construction require a modified approach when dealing with vehicles that have been in accidents.

The information is particularly intended for training rescue and recovery personnel. Appropriate rescue cards for Volkswagen vehicles are available for use at the scene of an accident.

You can find the latest versions at [www.volkswagen-rettungsfahrzeuge.de](http://www.volkswagen-rettungsfahrzeuge.de), although modifications to the vehicles may not be reflected in the rescue cards until later.



# 0. Rescue card(s)

# Volkswagen provides rescue cards for all its vehicle models and variants.



The example shown here is the first page from the rescue card of the Volkswagen ID.3, which is based on ISO 17840-1:2015.

The complete, up-to-date rescue card can be found at [www.volkswagen.de](http://www.volkswagen.de) along with all the other data sheets created by Volkswagen.









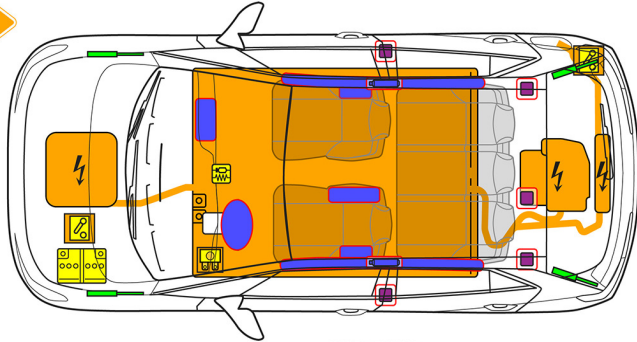
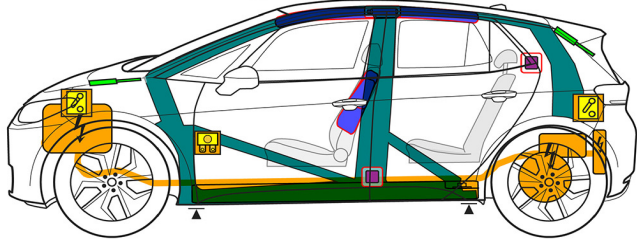









	Rescue cards for vehicles presented before 2020 may look different.
---	---



**ID.3**  
5-Türer, ab 2019

	Airbag		Gasgenerator		Gurtstraffer		SRS Steuergerät		Aktives Fußgängerschutzsystem
	Automatisches Überrollschutzsystem		Gasdruckfeder/vorgespannte Feder		Hochfeste Bereiche		Besondere Aufmerksamkeit		
	Niedervolt-Batterie		Niedervolt-Kondensator		Treibstofftank (Benzin oder Diesel)		Gastank		Sicherheitsventil
	Hochvolt-Batterie		Hochvolt-Leitung		Hochvolt-Trennung		Sicherungs-dose, Deaktivierung Hochvolt-system		Hochvolt-Kondensator

Zusätzliche Informationen  
Deutschland

Dokumentnummer  
rds\_www\_310\_001\_de

Version  
08/2019

# **1. Identification / recognition**



After an accident, high-voltage vehicles pose different hazards to emergency and recovery services than those presented by conventionally powered vehicles. This makes it crucial to identify these vehicles as soon as possible.

Volkswagen offers various hybrid vehicle models with a combined combustion engine and electric drive, as well as fully electrically powered vehicles known as e-models.

The hybrid models themselves come in two basic types:

- Hybrid vehicles with an external charging connection for the high-voltage battery (plug-in hybrid, PHEV)
- Hybrid vehicles without external charging (full hybrid, HEV)

The Volkswagen e-up!, which was launched in 2013, was the first fully electrically powered production vehicle. The e-Golf has since been added to the range, which will soon be completed with the ID. family. The ID. family is a new development, based on the modular electric drive matrix (MEB).



When emergency and recovery services are called out, for example after traffic accidents, it is essential that they can immediately identify high-voltage vehicles in order to judge the hazards at the site and take appropriate action.

The labelling of high-voltage vehicles has changed over the past few years and also varies among manufacturers and vehicle models.

## Distinguishing features of high-voltage vehicles

### 1. Features on the outside of the vehicle

- Lettering on the radiator grille, side panels and boot lid
- External charging connection for the high-voltage battery (charging flap in the radiator grille or behind the Volkswagen badge, charging flap with socket on the side of the body)
- No visible exhaust system (tailpipe, exhaust pipe)
- LED headlights with blue line and LED daytime running lights at the front or
- Curved reflectors on the rear with e-design

	Info
	Lit headlight surrounds on the ID.3 as LED daytime running lights
	Charging flap on the Golf GTE as of 2020
	Boot lid on the Passat GTE

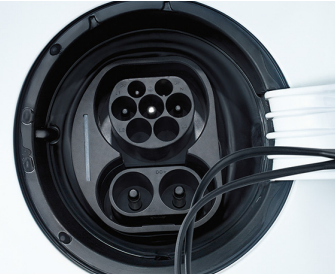
	<p><b>Info</b></p> <p>AC/DC charging socket</p>
---	---

	<p>AC charging socket</p>
---	---------------------------

## 2. Features in the engine compartment

- Orange high-voltage cables
- Standard international warning label for high-voltage technology
- High-voltage components

	<p><b>Info</b></p> <p>Orange high-voltage cables in the engine compartment</p>
---	--

	<p><b>Info</b></p> <p>Warning labels in the ID.3</p>
---	--

## 3. Features in the interior

- Specific instruments for electric vehicles in the instrument cluster, such as charging indicators (power meter)
- Specific displays for electric vehicles in the instrument cluster such as "Ready" for vehicle's drive system (electric drive is active, vehicle moves when the accelerator pedal is pressed)
- "E mode" button in the centre console
- Sport program button (GTE)
- Hybrid or GTE lettering, e.g. on the cockpit and/or steering wheel
- Hybrid lettering in the lower door panels

	<p><b>Info</b></p> <p>Digital instrument cluster with power meter and "Off" / "Ready" display for ID. family</p>
---	--



**Info**

No gear lever in ID. family  
 Parking brake on the steering column switch

## What does “high voltage” mean?

Fire brigades such as those in Germany have long been familiar with the concepts of low voltage and high voltage, along with the associated safety rules. However, the concept of high voltage used in electric and hybrid vehicle manufacturing is largely unfamiliar and can lead to confusion with the term used for electric power grids.





Therefore it makes sense to distinguish the terms here:

### Definition of terms used by fire brigades (example Germany)

- Low voltage: up to 1,000 V
- High voltage: more than 1,000 V

### Definition of terms used in vehicle construction (example Volkswagen)

- On-board voltage: up to 60 V (usually 12 V and 48 V for passenger cars and 24 V for trucks / commercial vehicles)
- High voltage: from 60 V to approximately 650 V

	<p>High voltage in a vehicle is not the same as high voltage in a power grid. This means that high-voltage systems in motor vehicles are still in the low-voltage range of up to 1,000 V as defined (in Germany for example) by fire brigades (similar to solar power systems in buildings, for example). Therefore, in Germany for example, the insurers' standard rules of action and safety instructions for electrical systems up to 1,000 V apply.</p>
	<p>Only a few electrical components in high-voltage vehicles (for example the high-voltage battery, high-voltage cables, power electronics, drive motor / alternator, air conditioning compressor, external charging connection) use vehicle high voltage. All the other electrical components such as the lights and vehicle electronics are powered by the on-board supply, which is 12 V for passenger cars or 24 V for trucks.</p>
	<p>Even though the terms are based on the voltage, the actual danger from direct contact with electrical energy is the strength of the current that flows through the human body in a closed circuit. This means that even low voltages can pose a lethal hazard if the current is high enough.</p>
	<p>Incorrect handling of high-voltage equipment can prove fatal due to high voltage and the associated risk of current flowing through the human body.</p>



## The high-voltage battery

High-voltage batteries are rechargeable accumulators. Various types of battery are used, depending on the manufacturer and the vehicle. They differ in the chemical components used in the battery cells for the anode, cathode and electrolyte, as well as in the shape of the cell (round, prismatic, pouch).

Lithium-ion batteries (Li-ion) are often currently used, for example.

The sizes and fitting locations of the high-voltage batteries differ depending on the type of vehicle. A purely electric vehicle needs a bigger high-voltage battery than a hybrid vehicle.



The following battery locations are common at present:

- Below almost the entire underbody
- Below the underbody in front of the rear axle
- Under a cover in the luggage compartment instead of the spare tyre well

A high-voltage battery consists of many battery modules, which in turn consist of the battery cells themselves.

In case of accidents, all high-voltage batteries are protected by design, for example to reduce the escape of electrolyte if battery cells are damaged.

The high-voltage battery is enclosed in a housing to mechanically protect it in the event of an accident. This directs most of the impact energy into the vehicle structure.

	In addition to the high-voltage battery, Volkswagen electric vehicles also have at least one 12-volt electrical system battery.
	Because there are so many different battery types with different chemical components and because battery technology is constantly developing, this guide cannot address the specific behaviour and hazards of each type.
	More information on the hazards can be found in section 5 "Stored energy / fluids / gases / solids".

## Battery concepts

Battery type

Location

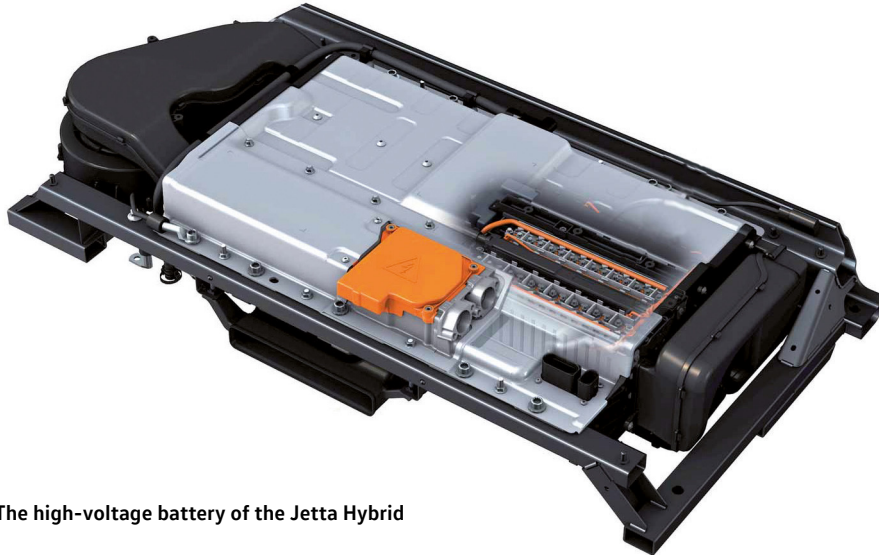

The high-voltage battery of the Jetta Hybrid

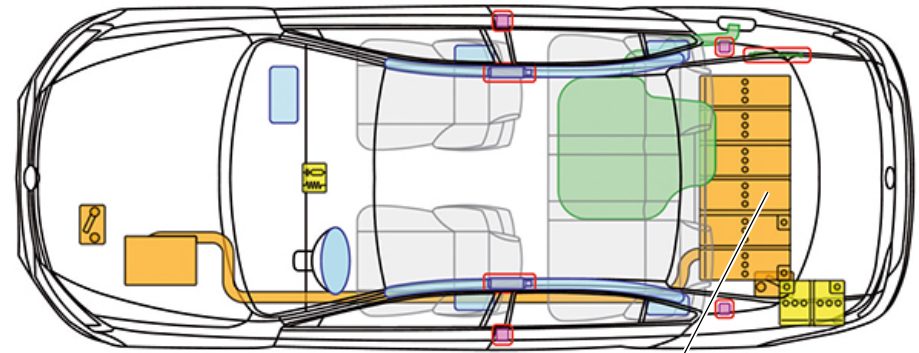

Location of the high-voltage battery as shown on the Jetta Hybrid rescue card.  
(The illustration does not correspond to the current ISO 17840-1.)

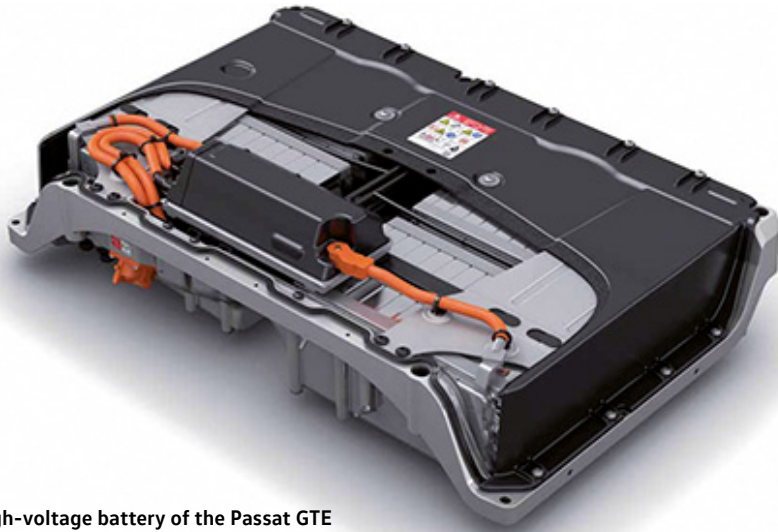

The high-voltage battery of the Passat GTE

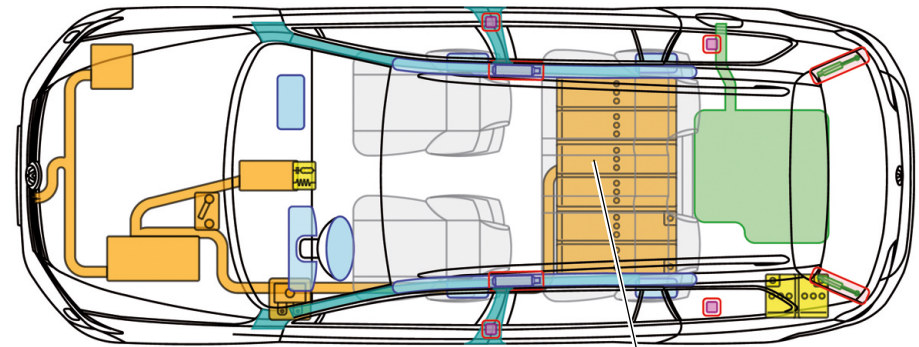

Location of the high-voltage battery as shown on the Passat GTE rescue card.  
(The illustration does not correspond to the current ISO 17840-1.)

## Battery concepts

Battery type

Location

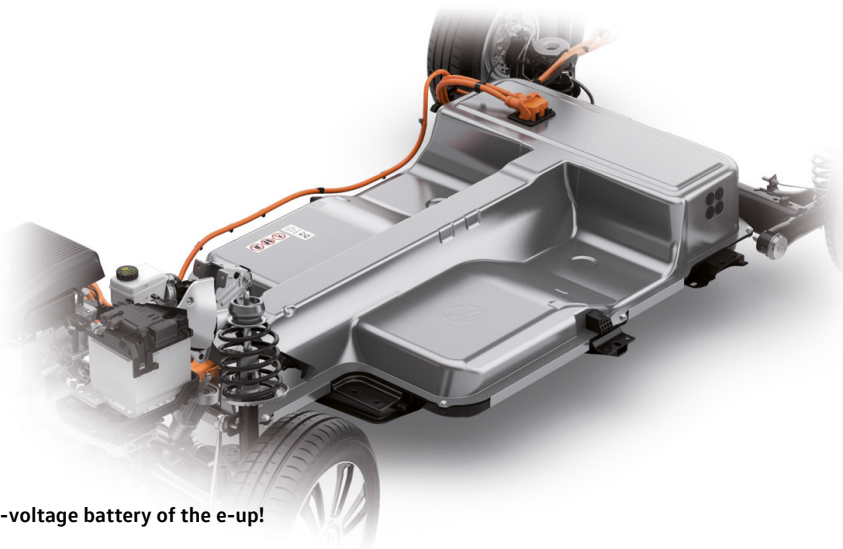

The high-voltage battery of the e-up!

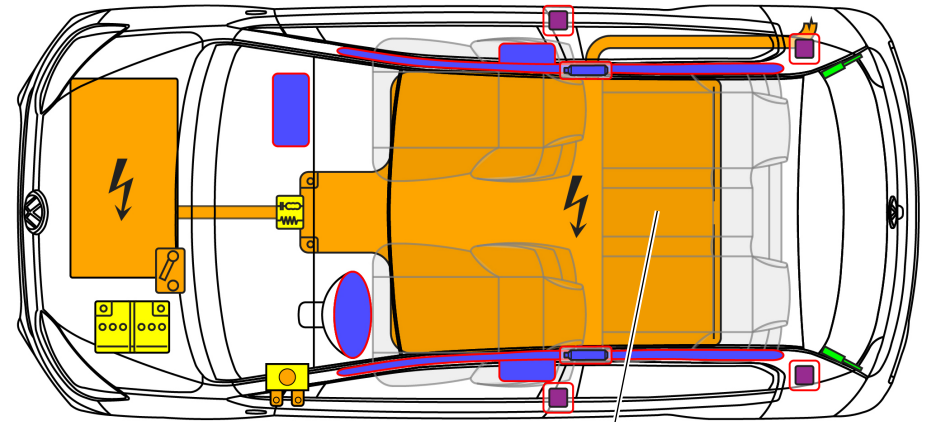

Location of the high-voltage battery as shown on the e-up! rescue card.

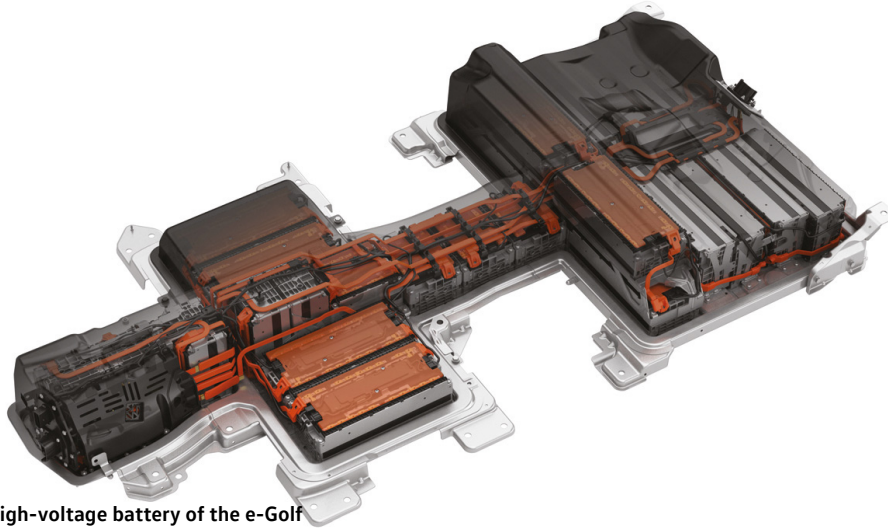

The high-voltage battery of the e-Golf

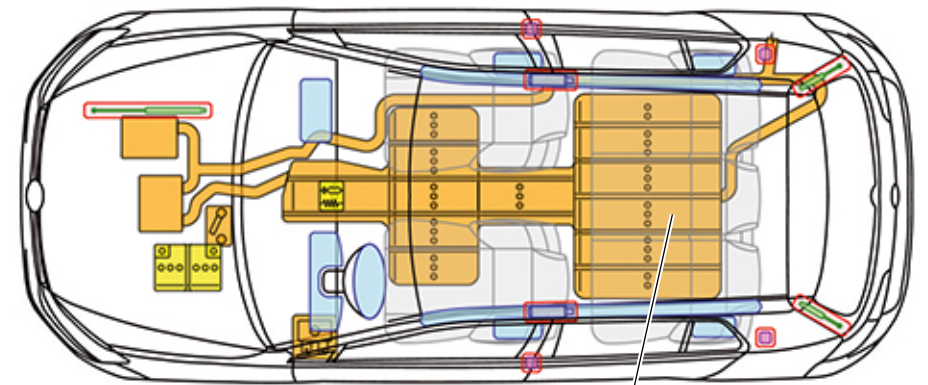

Location of the high-voltage battery as shown on the e-Golf rescue card.  
(The illustration does not correspond to the current ISO 17840-1.)



## Battery concepts

Battery type

Location

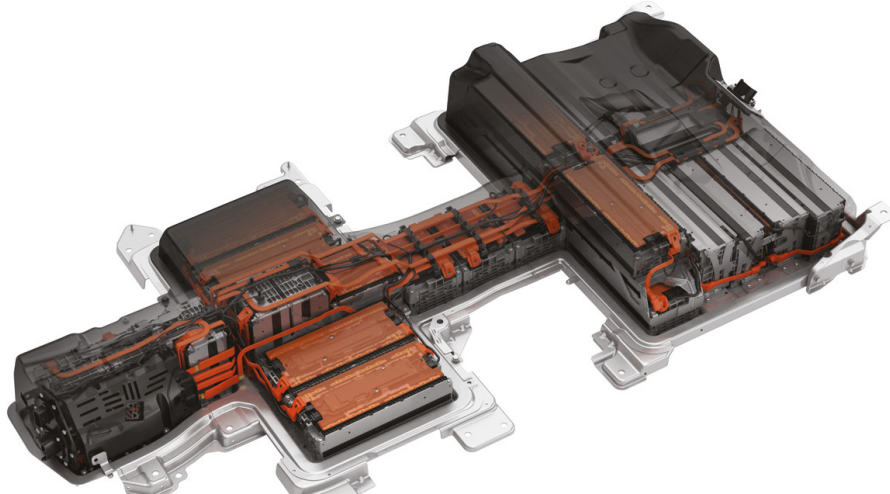

The high-voltage battery of the e-Crafter

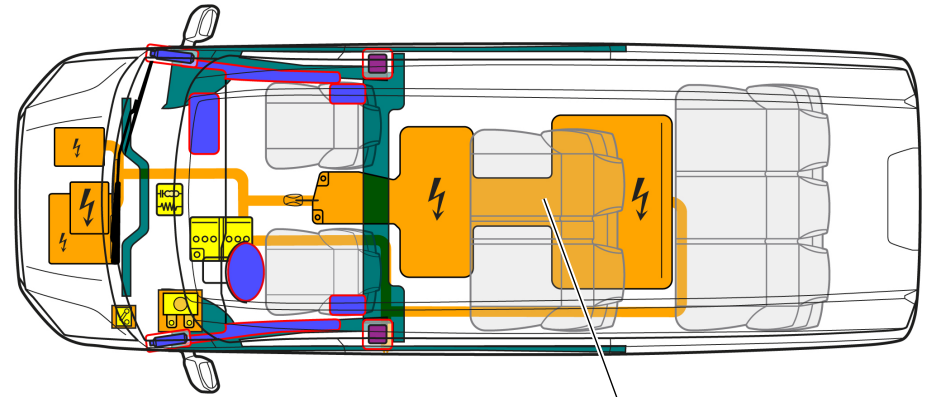

Location of the high-voltage battery as shown on the e-Crafter rescue card.

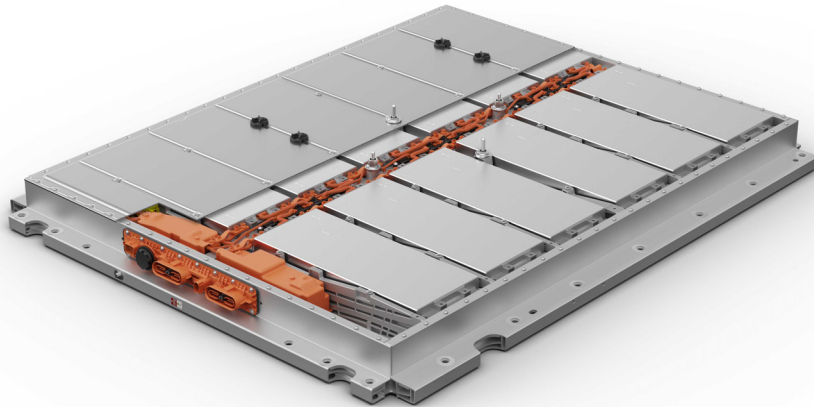

The high-voltage battery of the ID.3 (MEB)

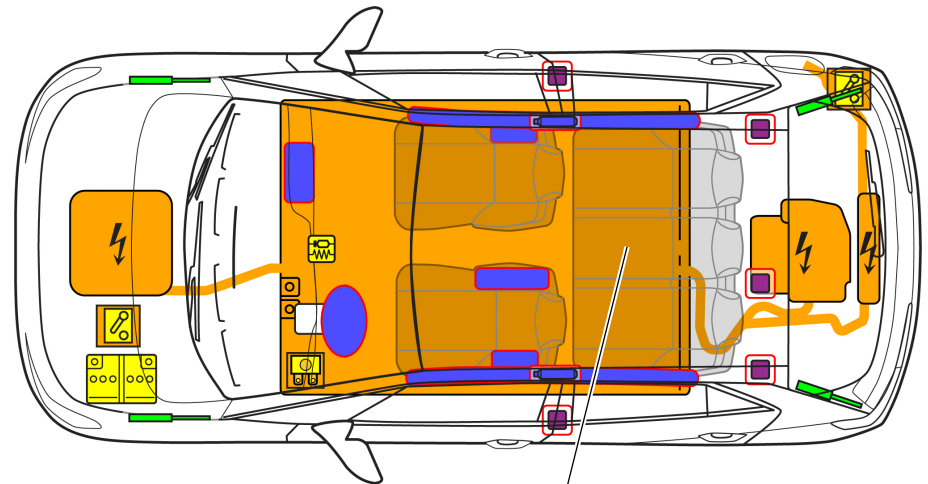



Location of the high-voltage battery as shown on the ID.3 rescue card.

# High-voltage safety

Each high-voltage vehicle has a comprehensive, model-specific safety concept.

This safety concept comprises:

- Warning labels
- Indicated cut-off points for disabling the high-voltage system
- The airbag control unit

	High voltage can present a danger in the event of direct contact due to the high voltage and current.
	More information on the warning labels can be found in section 5 "Stored energy / fluids / gases / solids".
	More information on the cut-off points for disabling the high-voltage system can be found in section 3 "Eliminating direct hazards / safety regulations" and on the respective rescue cards.

## **2. Immobilisation / stabilisation / lifting**

As the range of equipment used in vehicles increases, more and more devices consume energy, thus requiring a greater quantity or capacity of energy storage units.

This also affects the emergency services, because there are more issues to be taken into account, particularly when disabling the vehicle electrical system (switching off the ignition, disconnecting the vehicle batteries).

Disabling the vehicle electrical system not only reduces the risk of fire caused by short circuits, but also the risk of delayed deployment of airbags, belt tensioners or rollover bars. When disabling the vehicle electrical system, it should also be ensured that the power supply of any attached trailer is disconnected and any solar elements in the sliding sunroof are covered.



Disconnecting the 12-volt battery puts all electrical system functions out of operation (in particular the hazard warning lights and electric seat adjustment). Also observe the information in section 4 "Access to occupants" and section 9 "Important additional information".

## Prevent the vehicle from rolling

1. Locate the electric parking brake.
2. Set the electric parking brake.

Press the START/STOP button on the steering column. The READY display goes out.





Illustrations show the centre console of the Golf from 2020 onward as an example. (Left: electric handbrake, right: START/STOP button)

## Switch off the ignition

The electric drive motor is silent. The display in the instrument cluster (power meter) indicates whether the electric drive is switched off or ready for operation.





Example of the READY display in the ID.3.

	<p>Caution! Vehicles can switch to ready-to-drive mode when the START/STOP button is pressed at the same time as the brake pedal. Note the information in the rescue cards!</p>
	<p>The exact position of the READY display is described on the rescue card.</p>

## Lifting the vehicle

The points where the vehicle can and cannot be lifted are indicated in the rescue cards.

	<p>If possible, lift up the vehicle at the indicated lifting points.</p>
	<p>This applies to vehicles without deformation.</p>
	<p>For deformed vehicles, the emergency and recovery services on site must decide at which points to raise the vehicle.</p>



# **3. Disable direct hazards / safety regulations**

Many emergency and recovery personnel are uncertain about the hazards they face when called out to accidents involving high-voltage vehicles.

## Cut-off points for disabling the high-voltage system

The cut-off points are specifically incorporated by the manufacturers to give emergency services an easily accessible way to safely disable the high-voltage system.



Because some types of accident may prevent access to the engine compartment (for example when a car is stuck under a lorry), there are usually at least two cut-off points: one in the engine compartment and one in the luggage compartment or the interior.

These cut-off points indicated by yellow flags only carry the 12-volt onboard supply voltage, which means they can be safely disconnected by the emergency personnel using the procedure described on the flags.

Some vehicle models may also have a cut-off point on one of the fuse carriers (for example in the interior near the dash panel), also indicated with a yellow flag. In this case, the high-voltage system is disconnected and disabled by pulling out the fuse indicated in this way.

In both cases, the safety relays in the high-voltage battery open, disconnecting it from the rest of the high-voltage system, which is then de-energised after 20 seconds.

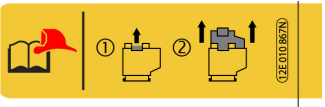
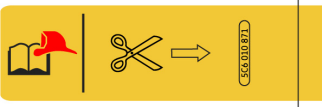
The positions of the cut-off points and the procedure for disabling the vehicle are shown on the Volkswagen rescue cards.

	<p>Indicates the emergency cut-off point in the passenger compartment (fuse in carrier)</p>
	<p>Indicates the emergency cut-off point in the engine compartment</p>
	<p>Indicates the emergency cut-off point in the luggage compartment</p>
	<p>Disconnecting a marked cut-off point only disables the high-voltage system. Safety systems such as airbags or belt tensioners remain powered by the 12-volt electrical system.</p>

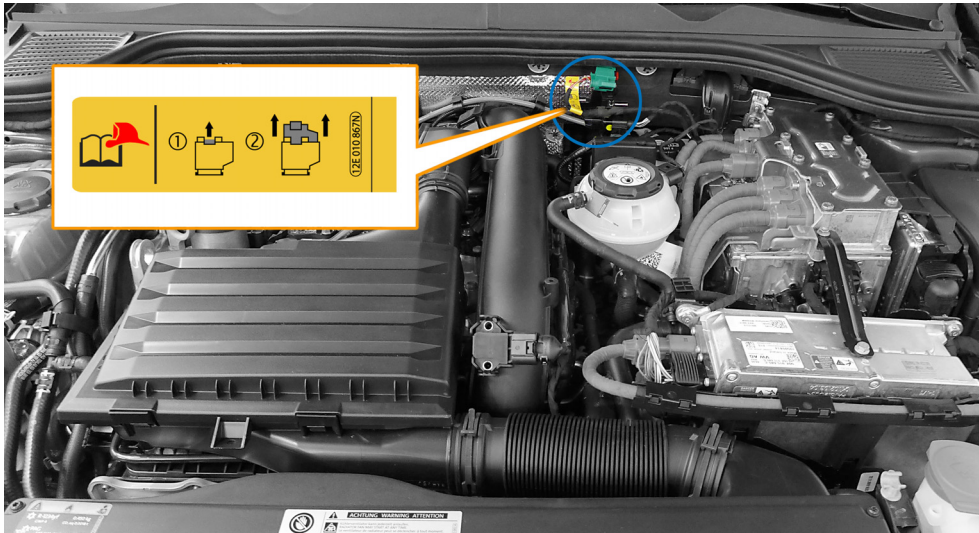

Cut-off point in hybrid vehicle (Golf GTE from 2020)

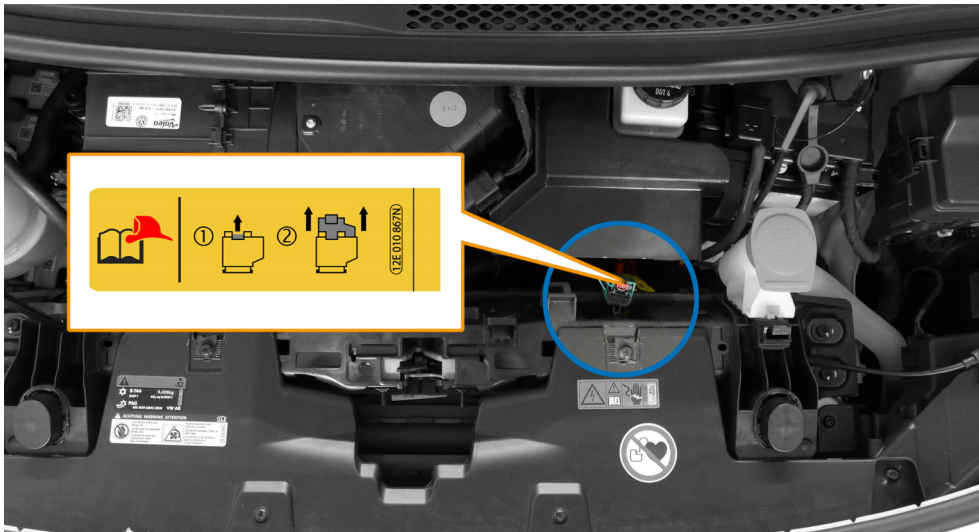

Cut-off point in electric vehicle (ID.3)

## Disabling the vehicle



Electric and hybrid vehicles run extremely quietly in electric mode. This means that unlike conventional combustion engines, it is impossible to tell from the noise whether a high-voltage vehicle's motor is on or off. This makes it particularly important to disable a high-voltage vehicle and secure it against rolling away or starting off. Observe the information on the rescue cards.

Different procedures may be necessary, depending on the vehicle type and equipment. The way in which the vehicle is disabled depends on the accident situation and the vehicle equipment.

The following possibilities, amongst others, must be kept in mind:

- The vehicle may still have a traditional ignition lock or it may have Keyless Entry, a system where the ignition key can switch on the vehicle from anywhere inside it (such as the driver's pocket or handbag). Some vehicles can also be controlled using an app.
- If there is an ignition key, turn it to the "off" position or take it out of the lock
- If the vehicle has an Engine On/Off button in addition to the ignition lock, press it to disable the vehicle.









The required procedure can be found in the Volkswagen rescue cards.



Maximum certainty that the vehicle and above all the high-voltage system have been disabled is only possible when a cut-off point provided by the manufacturer and therefore the 12-volt onboard supply battery have been disconnected, or if the airbag control unit has detected the accident and disconnected the system.

## Use rescue equipment with caution and consideration near high-voltage components

Whether it is a hybrid or an electric vehicle, the following points always apply during emergency operations on high-voltage vehicles.

	<p>Incorrect handling of high-voltage equipment can prove fatal due to high voltage and the associated risk of current flowing through the human body. Therefore, if possible, keep a distance from the damaged high-voltage components and avoid contact when working on high-voltage vehicles that have been in accidents.</p>
	<p>If the airbags have deployed, the high-voltage system will have already been switched off; this means the emergency and recovery services can act immediately. Do not perform any work on badly damaged high-voltage components. The emergency cut-off point can also be disconnected. If the airbags have not deployed, the vehicle must be disabled by the emergency and recovery services using a cut-off point. After approximately 20 seconds, the high-voltage components will be disabled.</p>
	<p>Even after disabling the high-voltage system, there is still a charge in the high-voltage battery. This means the high-voltage battery must not be damaged or opened during the rescue measures. If the high-voltage battery has been damaged in the accident, avoid contact with it or with liquids and vapours leaking from it.</p>
	<p>The insulation of the high-voltage cables is orange. High-voltage cables must not be damaged or disconnected from the high-voltage system by non-qualified personnel.</p>
	<p>Work on damaged high-voltage components is not permitted because the shut-off system may have been damaged in the accident. Cover damaged components with suitable equipment such as insulating blankets.</p>
	<p>Undamaged high-voltage components can be touched.</p>

## Disconnecting a charging station

Because high-voltage vehicles are usually charged when parked, public car parks, private carparks and public or private garages may have high-voltage charging stations which a vehicle can be connected to.

The more high-voltage vehicles come onto the market, the more common public and private high-voltage charging stations will become. This must be taken into account by rescue and recovery services called out to emergencies and fires when assessing the situation and deciding which measures to take.

A general distinction should be made between public charging stations, which may have several spaces, and private charging stations.

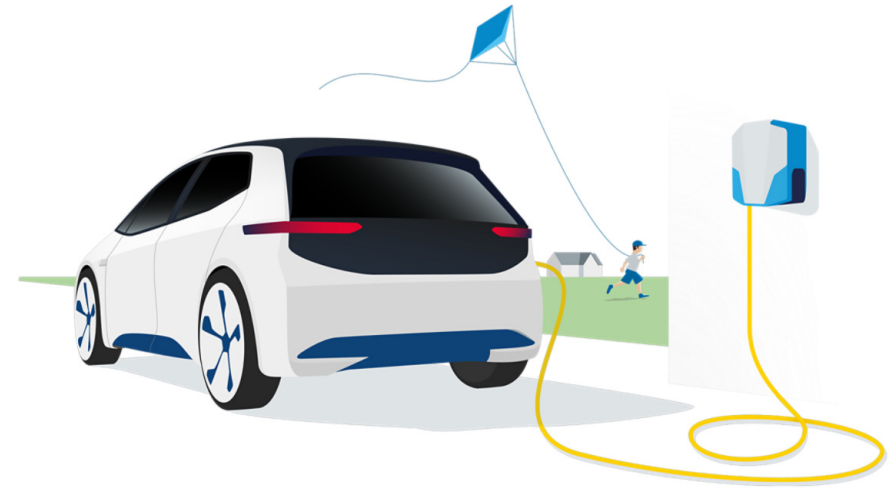

Public charging stations may be connected to the public high-voltage network at more than 1,000 volts. If this is the case, the correspondingly larger safety distances must be observed when responding to fires.

Another difference is the type of charging voltage. Some systems charge with alternating current while others charge with direct current.



In systems with direct current, the battery is supplied directly via the charging connection. If alternating current is used to charge the high-voltage battery, the charging unit in the engine compartment acts as a voltage converter. The type of charge voltage can be recognised from the different charging sockets.



AC/DC charging socket



AC charging socket

	<p>Observe existing regional and national contingency plans for emergency and recovery services for public charging stations.</p>
	<p>The charging connections and the appearance of public and private charging stations differ depending on the manufacturer and country.</p>





## **4. Access to the occupant**

## Body and materials

One particularly effective way to optimise safety for the vehicle occupants is to make the passenger compartment as rigid as possible.

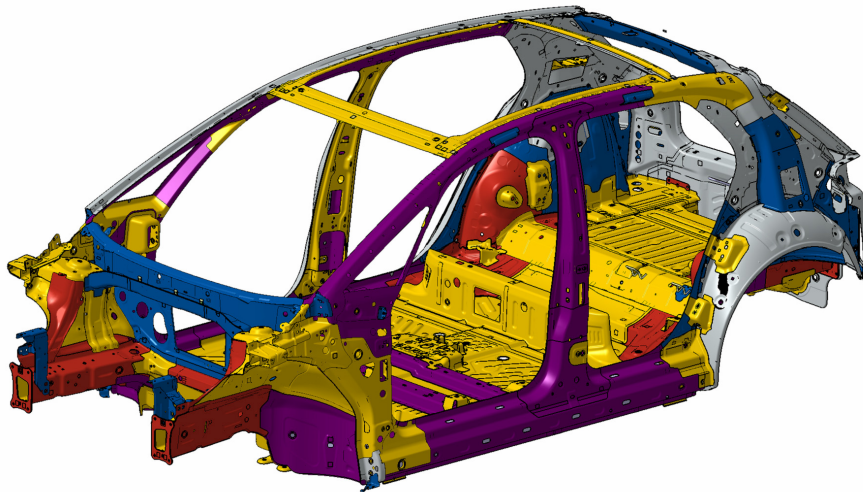
This is done using extra-high-strength steel, thicker walls and a multi-shell structure. In modern vehicles, these areas must be avoided if possible when rescuing the occupants in an accident, but if they must be opened, it requires sufficiently powerful cutting equipment.





	Hot-formed steel can be cut through using high-power cutting tools.
	Information on the position of reinforcements can be found in the rescue cards for the specific vehicle.

## The A-pillar

Convertibles in particular have an additionally reinforced body in order to achieve the necessary rigidity even without a roof. Reinforcing tubes are fitted at various places in the vehicle including the A-pillar in order, together with the rollover bars, to optimise the protected area if the vehicle overturns.

It may also be possible to open the convertible roof (which is usually a fabric roof) by conventional means or by pushing up the roof with a ram.



	The A-pillar can only be cut with shears in the area of the A-pillar reinforcements with great effort and then only with very powerful equipment.
	The position of special reinforcements in individual vehicles can be found in their rescue cards. The reinforcements are represented as follows:
	Indication of high-strength areas as per ISO 17840

## The B-pillar

The B-pillar in particular is reinforced using extra-high-strength and hot-formed sheet metal and a multi-shell structure. In addition, modern B-pillars have a larger cross-section.

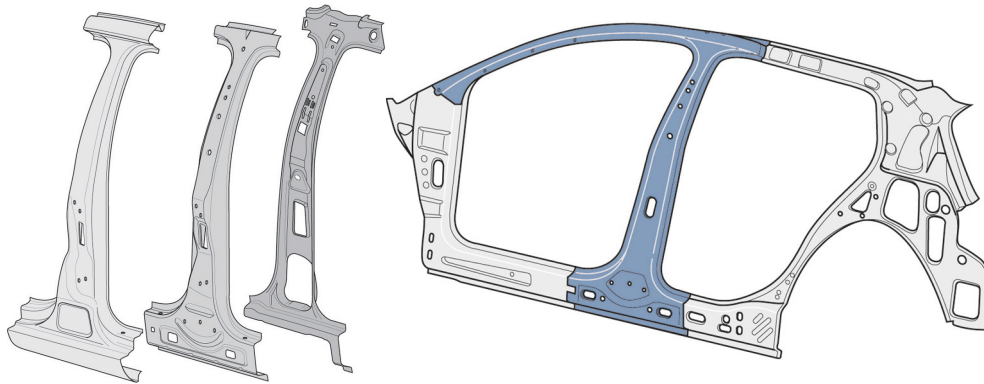
The pillar is additionally reinforced around the belt guide, which makes it more difficult to cut through. These areas should therefore be deliberately avoided.



	<p>The easiest point to cut through vehicle pillars is the area above the belt height adjuster. The bottom of the pillar can also be cut through, but it should be kept in mind that this part of the pillar has a very large cross-section and usually contains the belt tensioner.</p>
	<p>Always observe the rescue cards!</p>



## The side members

In modern vehicles, special steels are used to reinforce the side members. These increase safety in the event of side collisions, especially if the vehicle hits a pole.

### Side impact protection

Volkswagen Group vehicles are protected from side impact with steel tubes or steel sections. The tubes or sections are arranged horizontally or diagonally behind the outer door panels.

The high-strength sections can be cut through with powerful cutting equipment.

	<p>The position of special reinforcements in individual vehicles can be found in their rescue cards. The side impact sections are represented as follows:</p>
	<p>Indication of high-strength areas as per ISO 17840</p>

## The windows

The windows in Volkswagen Group vehicles are made of toughened or laminated safety glass. The windscreen is always made of laminated glass and the side and rear windows are made of toughened glass. In modern vehicles, laminated glass may also be used for the side and rear windows.

### Toughened safety glass

Toughened safety glass is thermally tempered glass that can withstand high loads. When broken it crumbles into small granular pieces. Toughened safety glass is used for side windows, rear windows and sliding sunroofs.



	<p>Intact windows can suddenly burst during rescue work. Depending on the accident situation and the scope of emergency work, the windows should be removed first. Windows can be removed by concentrated impact using an automatic punch or an emergency hammer, for example. The windows should first be secured.</p>
---	---

### Laminated glass

Laminated glass consists of two panes of glass with a layer of film in between. The glass remains largely intact when damaged. It is used for windscreens and sometimes for side windows. The windscreens are bonded to the body with adhesive.

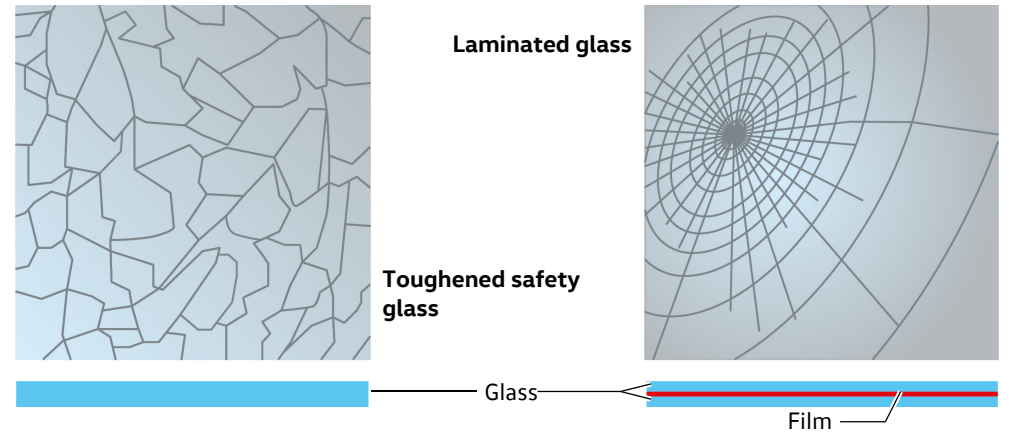
	<p>Because laminated windscreens cannot suddenly burst, they only have to be removed if it is necessary for the rescue work. Laminated windows can be removed using special glass saws or metal cutting claws.</p>
---	--



	<p>Protect the occupants from shards of glass before removing windows.</p>
	<p>Information on installed laminated glass (other than the windscreen) can be found in the relevant rescue cards.</p>



## Driver seat and steering wheel adjustment mechanisms

The seats and steering column in Volkswagen vehicles may be operated mechanically or electrically.

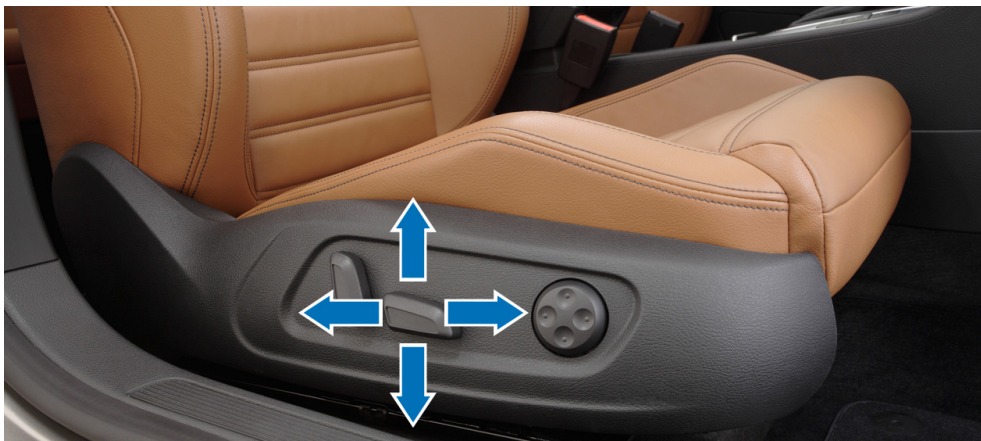



## Electric convenience systems

Depending on the model series and vehicle equipment, Volkswagen AG vehicles have a range of electrically operated convenience systems, for example:

- Electric doors
- Electric windows
- Electric sliding sunroof
- Electric seat adjustment
- Electric steering column adjustment
- Electric unlocking of the luggage compartment

If the battery or batteries are disconnected, these systems can no longer be operated.

	If possible, use the electrical convenience systems for rescue before disconnecting the battery.
	The battery should only be reconnected to the vehicle electrical system by workshop personnel.

**5. Stored energy / liquids / gases / solids**

Only if you recognise a hazard during an emergency can you react appropriately and take suitable action to prevent it.

This is why comprehensive and internationally standardised warning labels are part of the safety concept.

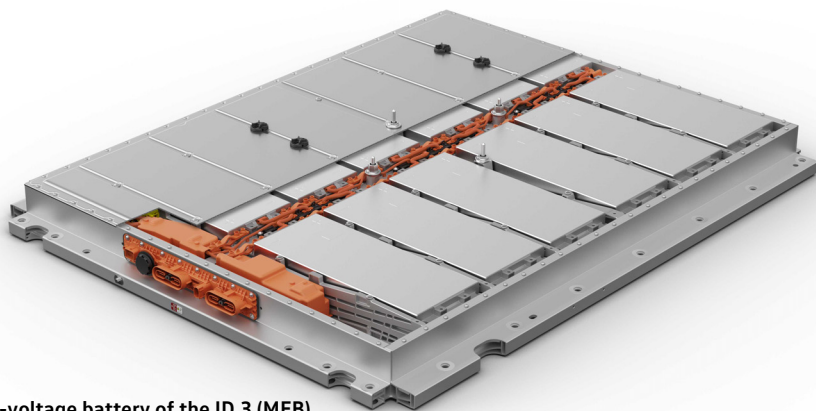

The high-voltage battery of the ID.3 (MEB)

## Warning labels for high-voltage components

All high-voltage components are marked with unambiguous warning stickers. An exception to this are the high-voltage cables, which are immediately recognisable by the orange warning colour of their sheathing.

Three types of warning sticker are always used:

- Yellow stickers with a warning symbol for electrical voltage
- Stickers with the word "Danger" on a red background
- Stickers with a special warning for people with pacemakers

The yellow stickers refer to the high-voltage components that are installed near the sticker or concealed under covers.

The warning stickers with the word "Danger" directly indicate the high-voltage components.



Examples of warning stickers in high-voltage vehicles.



### Air conditioning system

The refrigerants R134a, R1234yf and R744 are used in air conditioning systems. For more information about the various coolants go to: <https://www.dguv.de/ifa/gestis/gestis-stoffdatenbank/index.jsp>

### Compressed air tanks

Some Volkswagen models have accumulators for pneumatic suspension or air conditioning systems, for example. Do not damage these accumulators and never open them by force. The installation position is indicated in the rescue cards for the vehicle model.

### Flammable materials

Examples of these include:





- Plastics
- Electrolytes
- Resins
- Magnesium
- Gases or other combustible materials.

Resins are used for connecting carbon fibres, magnesium components are used in the engine compartment and gases can escape from the high-voltage battery.

### Battery information, general first aid measures and environmental protection

#### aspects:

In normal operating conditions, there is no risk of exposure to the contents of the battery.

	Exposure to the high-voltage system (voltage above 60 V) must be avoided because it can be fatal.
	If a person has come into contact with the voltage, seek medical advice.
	Avoid skin contact and inhaling electrolyte vapours, as electrolyte is combustible, corrosive and irritating.
	Contaminated extinguishing water must be dealt with according to the national procedures for emergency and recovery services.



**6. In case of fire**

## If a high-voltage vehicle is on fire, the instructions must be observed in the same way as for a normal vehicle fire.

Harmful smoke is produced from fires in electric or hybrid vehicles, just as it is with conventional vehicles.









Due to the safety technology used, there is no risk of the entire high-voltage battery exploding. All that happens is a thermal reaction.

In the event of a fire, gas is likely to escape from the high-voltage battery because both the battery and its individual cells have mechanical safety devices which open when the temperature and pressure increase, for example due to a fire, specifically in order to let out gas and relieve the pressure.

It is possible to extinguish a vehicle with a high-voltage battery and to extinguish the high-voltage battery itself. According to the VDA guide on rescue and recovery in accidents, water is the most suitable extinguishing agent and there is no fundamental difference from fighting a fire in a conventionally powered vehicle. It also has a cooling effect.

If the high-voltage battery is involved in a fire, large quantities of water are required to cool or extinguish an undamaged, reacting high-voltage battery.

The cooling may prevent or reduce additional thermal reactions. When extinguishing the high-voltage battery, the safety valves of the battery cells may open, which can be heard from the outside but does not present a danger.

	If the airbags did not deploy during the accident, they may deploy in the event of a vehicle fire.
	After putting out the fire, there may still be hazardous voltages.
	When batteries are not completely burnt out, they may ignite again. Extinguished vehicles must be moved to a safe position; the vehicle may have to be watched.
	A sufficient safety distance must be maintained.
	Self-contained breathing apparatus must be worn when putting out fires. Evaporation and gases can be suppressed by spraying jets of water.
	Defective cells may burst, causing an exothermic reaction.
	A fire may break out some time after the accident, as there may be a residual risk of delayed fire. This is particularly the case if the high-voltage battery is damaged (see also section 8 "Removal / transport / storage"). An electrical hazard may also persist. High-voltage components must not be touched and suitable protective equipment must be worn. High-voltage cables may have been damaged by the heat.
	More information can be found on the respective rescue cards.

	Personal protective equipment must be worn, including self-contained breathing apparatus!
---	---

## **7. In case of submersion**

## Electric or hybrid vehicles in the water do not pose any particular risks of their own.

- When it is in the water, the high-voltage system does not present an increased risk of electric shock.
- The same instructions as described in section 3 "Eliminating direct hazards / safety regulations" apply.
- The recovery procedure is the same as for conventional vehicles. This also applies to bodies made of carbon fibre reinforced polymers.

Source: Verband der Automobilindustrie (VDA), Unfallhilfe & Bergen bei Fahrzeugen mit Hochvolt-Systemen, FAQ.

# **8. Towing / transportation / storage**



## It is always permissible to recover accident vehicles from a dangerous area.

When loading, transporting and storing them, the instructions on the rescue cards must be observed. Vehicles with high-voltage batteries should always be taken away on flatbed vehicles.

Before transport, the high-voltage system must be disabled, see section 3 "Eliminating direct hazards / safety regulations".

Vehicles with a damaged high-voltage battery should be transported to a safe storage location.

After transport, electric or hybrid vehicles that have been in accidents should not be parked in enclosed buildings, but outdoors at a sufficient distance from other vehicles, buildings and combustible objects or surfaces. If possible, use designated "quarantine areas" at the storage location.

	When loading the vehicle, take care not to damage the high-voltage components. If possible, lift up the vehicle at the indicated lifting points.
	Vibration during transport may cause high-voltage batteries to ignite again.
	Recommendations for specific vehicles can be found on their rescue cards.



# **9. Important additional information**

Modern vehicles have extensive occupant protection systems, which can vary according to the vehicle type and specification package.

## Airbag

A current vehicle with the highest equipment level (for example the Golf from 2020 onwards) includes the following main components:

- Airbags
- Airbag control unit
- Sensors
- Belt tensioners
- On convertibles, components to trigger the rollover bar.

Deployment takes place using pre-tensioned springs or pyrotechnics. The job of the electronics integrated in the airbag control unit is to detect vehicle deceleration and acceleration and decide whether to deploy protection systems.

In addition to the internal sensors in the airbag control unit, external sensors are also used to record vehicle deceleration and acceleration during an accident. Only once they have evaluated the information from all sensors do the electronics in the airbag control unit decide whether and when to activate the safety components. Depending on the nature and severity of the accident, they may only deploy the belt tensioners or the tensioners together with the airbags, for example.

The control unit is indicated as follows on the rescue cards:

	Identification of airbag control unit as per ISO 17840
---	--

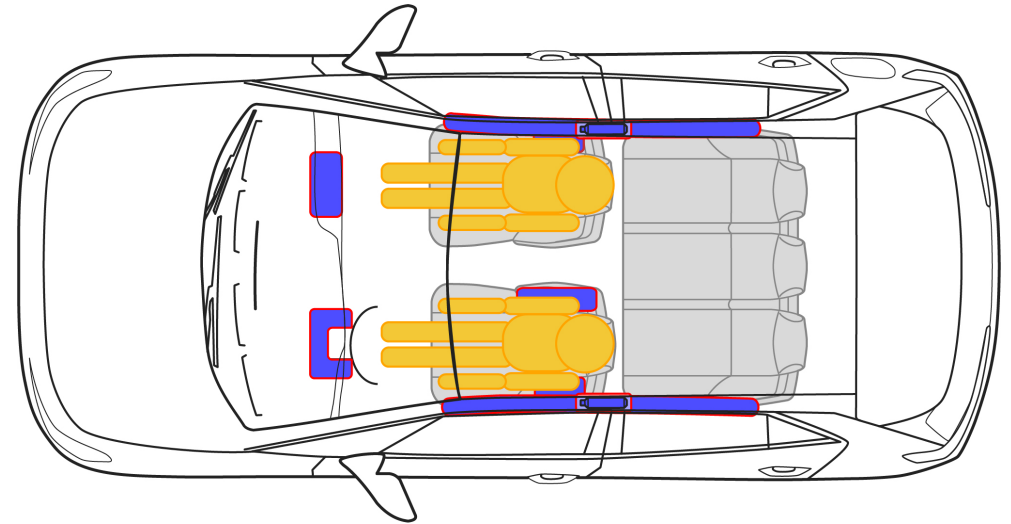

**Airbags in the ID.3**

Only those safety systems which afford protection in the specific accident situation are triggered.

In addition to the main function for controlling the airbags, the airbag control unit may also have the following functions:

- Emergency release of the central locking
- Switching on the interior lights
- Switching off the fuel pump
- Switching on the hazard warning lights

Gas generators produce the quantity of gas required for inflating the airbags. The inflated airbags protect vehicle occupants who are wearing seatbelts from hitting interior body contours (steering wheel, dash panel etc.) in the event of a serious accident.

Depending on the installation location and requirements, gas generators of various designs or modes of action are used.

The safety systems are triggered depending on the type of accident or direction of impact

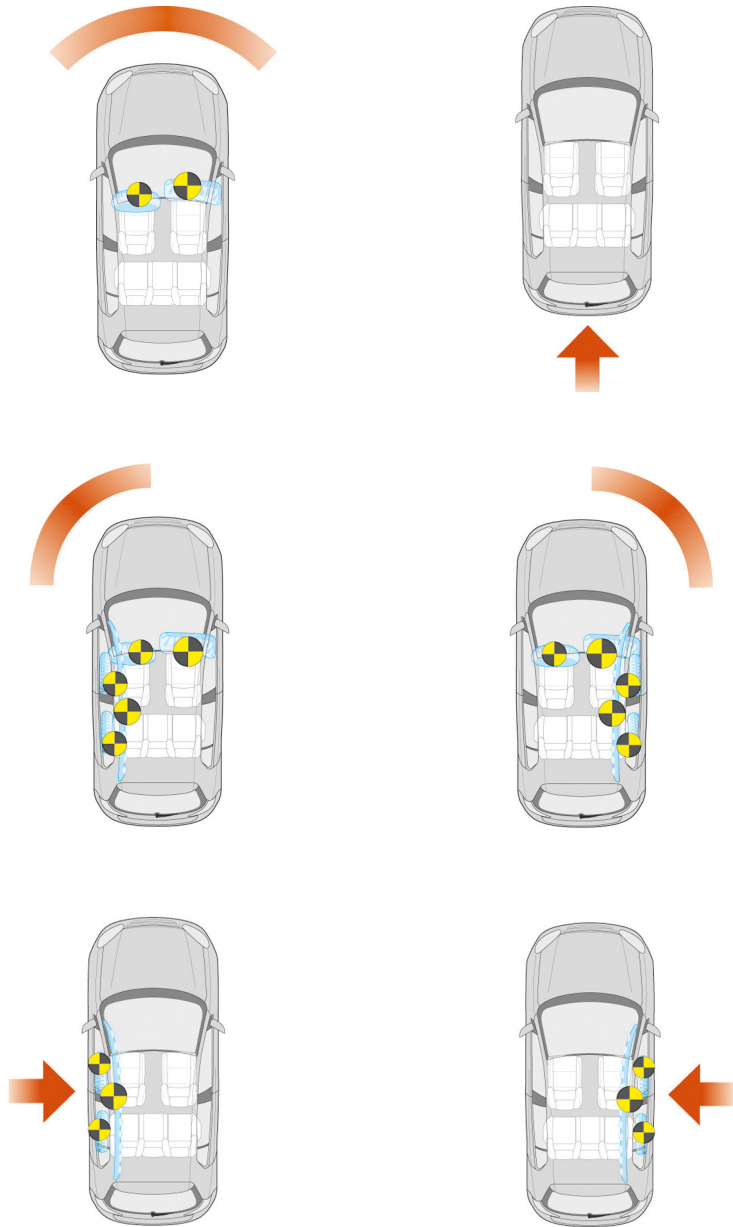

The safety systems are triggered depending on the type of accident or direction of impact

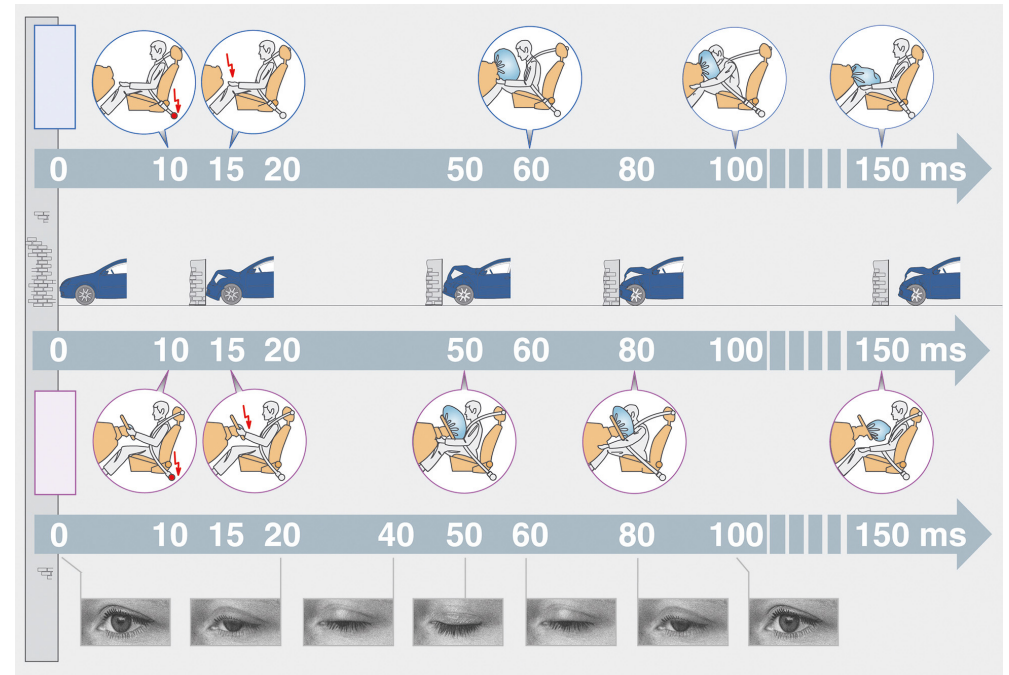

Airbags are indicated on the rescue cards as symbols or outlines as follows:

	<p>Driver airbag, front passenger airbag, side or centre airbag, knee airbag and curtain airbag</p>
--	---

## Front airbags

### Driver airbag

The driver airbag unit essentially consists of a cap, the airbag and a gas generator. It is fitted in the steering wheel and electrically connected to the airbag control unit via a contact unit.

The airbag is folded up under the cap and its shape and size are designed so that it inflates as protection between the driver and steering wheel.

The driver airbag is inflated by a gas generator. The unfolding airbag breaks the cap on the steering wheel along a special seam and is instantly filled with gas. The entire process from ignition of the gas generator to the fully inflated airbag only takes a few milliseconds.

Vents on the side facing away from the driver reduce the kinetic energy of the upper body impact by allowing the gas to escape at a controlled rate.

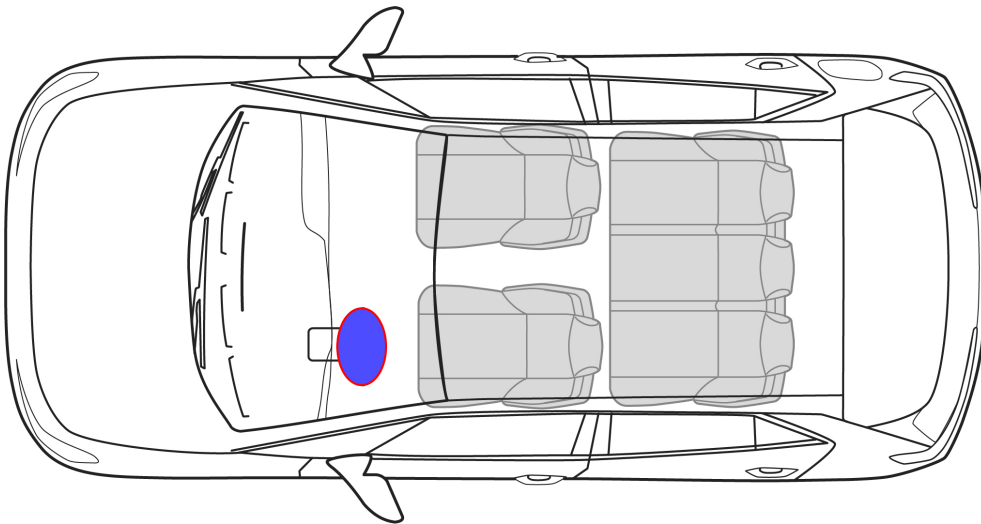

## Front passenger airbag

The airbag unit for the front passenger is located in the dash panel in front of the passenger seat. Because the airbag unit is further from the occupant, the front passenger airbag has a much larger volume.

The action, function and process sequence of the front passenger airbag are comparable to those of the driver airbag.

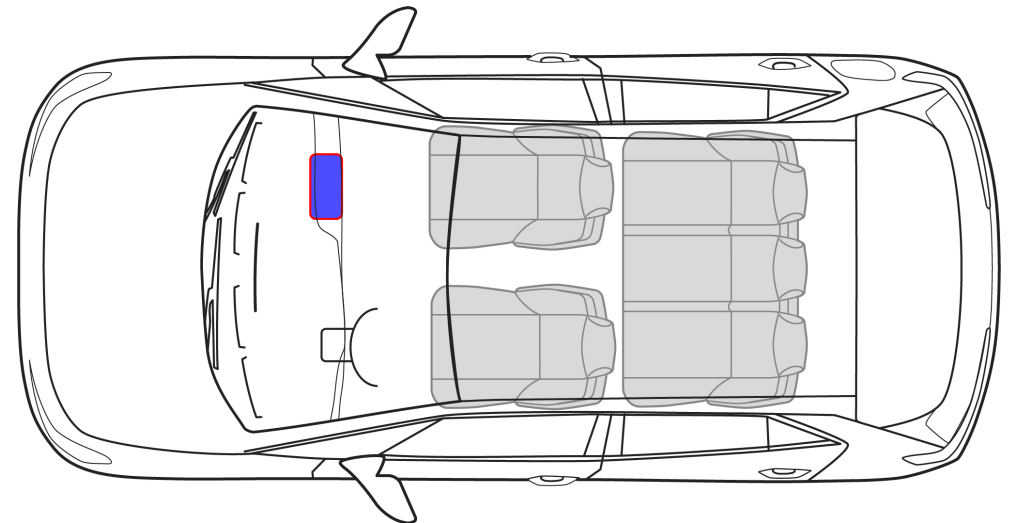

## Dual-stage front airbag

For an airbag with a one-stage gas generator, the entire propellant charge is ignited at once.

For airbags with two-stage gas generators, the propellant charges are activated one after the other. The airbag control unit determines the time between the two ignitions based on the severity and type of accident. Depending on the vehicle, the delay can be between 5 ms and 30 ms.

The second stage supplies the airbag with an additional volume of gas. The time gap

between the two ignitions determines how hard the airbag is when inflated. If the second ignition takes place later, the airbag has already lost some of the pressure from the initial deployment and the inflated airbag is relatively soft. If two ignitions take place in quick succession, the airbag has not yet lost pressure from the initial deployment and it inflates harder.

Both stages are always ignited. This is to prevent any propellant charge from still being active after the airbag is deployed.

Indication on the sun visor for dual-stage airbag systems



	In such a case, a deployed driver or front passenger airbag should be treated like an airbag that has not deployed.
---	---

## Knee airbag

The design of the knee airbag is similar to that of the front passenger airbag. It is located in the footwell trim below the dash panel.

The knee airbag is always deployed together with the driver airbag. Single-stage gas generators are used to inflate the knee airbags.

The deployment of the knee airbag reduces the occupants' risk of knee and leg injury, and connects the occupant sooner to the vehicle's deceleration.

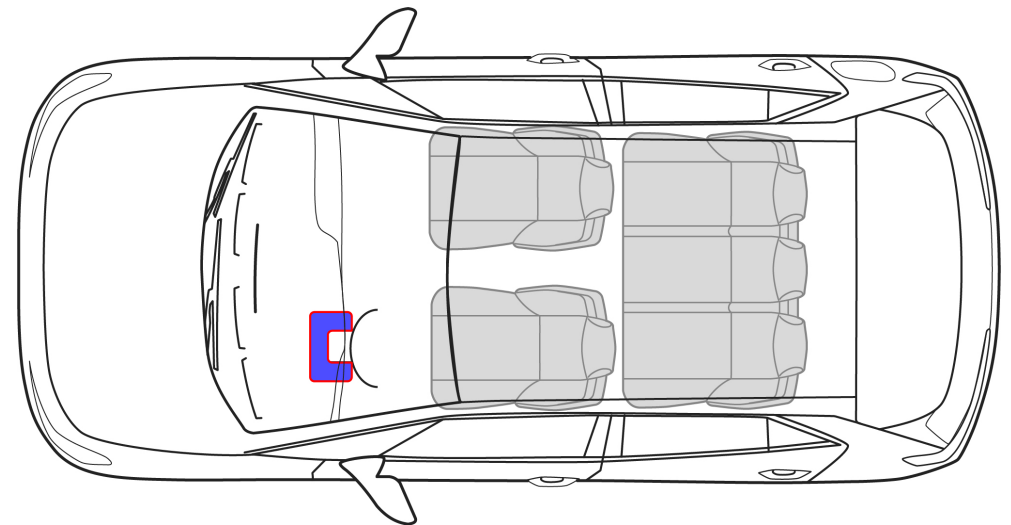

## Side airbag

In a lateral collision, side airbags protect the occupant's thorax and pelvis on that side of the vehicle and reduce the impact on the occupant. They inflate at the side between the occupant's upper body and the penetrating trim, and thus more evenly distribute the force of the impact on the occupant who is thus connected to the intrusion movement early on.

The side airbags are located in the backrests of the driver and front passenger seats. This ensures a constant distance from the occupant however the seat is adjusted. Side airbags can also be fitted for the rear seats, in which case they are located in the backrest or in the side trim.

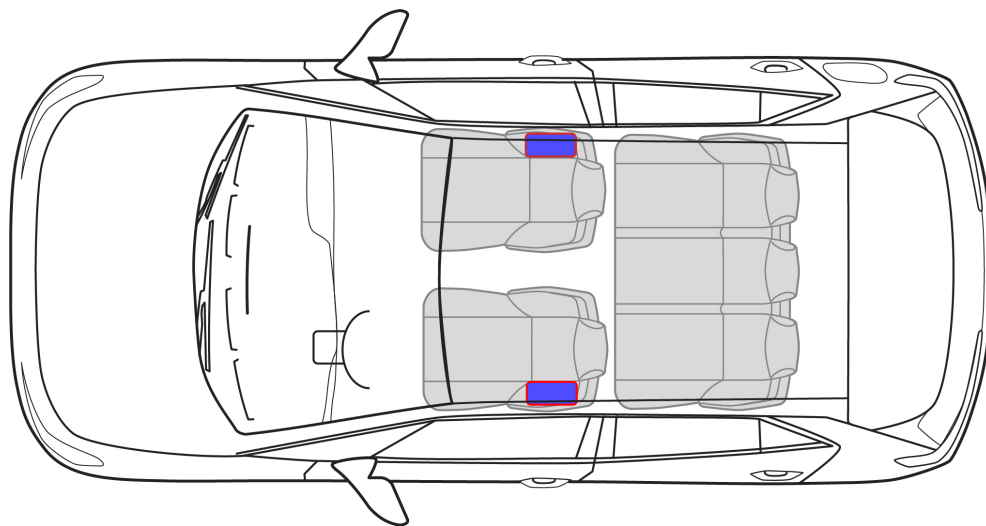

## Head-thorax airbags

The head-thorax airbags for the driver and front passenger are integrated in the front seat backrests. The design and function are similar to those of a side airbag. It extends from the occupant's ribcage to the head and is particularly used in convertibles where a curtain airbag is not possible.

## Centre airbag

Centre airbags are installed in the backrest of the driver seat.

They prevent a collision between the heads of the driver and the front passenger, and prevent the driver from being thrown too far to the passenger side if it is unoccupied.

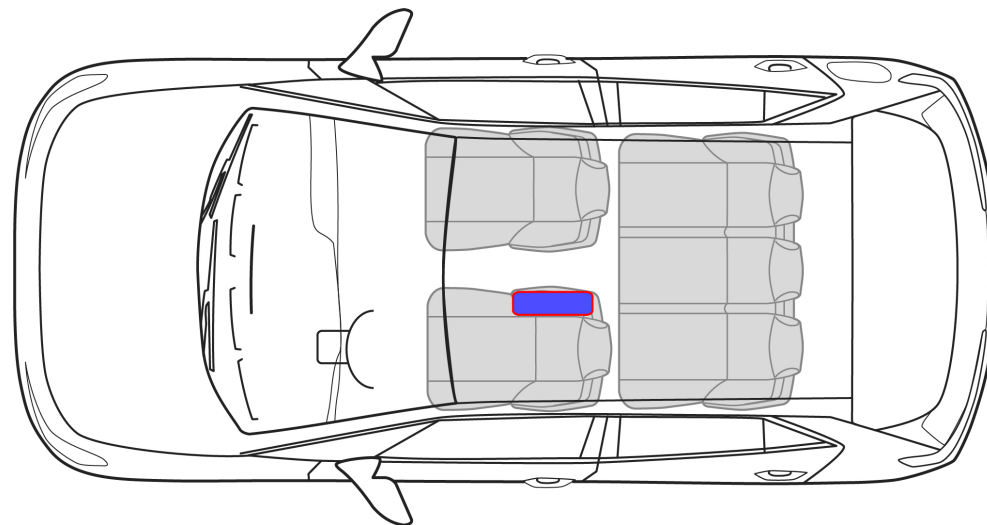



## Curtain airbags

Curtain airbags protect the head in the event of a side impact. They consist of a large airbag up in the roof lining which usually extends from the A-pillar to the C-pillar.

Depending on the vehicle model, the gas generators may be installed in the roof near the B-pillar, between the B- and C-pillars, between the C- and D-pillars or even in the rear roof area. The exact installation position is described on the rescue cards.

Unlike front and side airbags, the curtain airbag can retain its internal pressure for some time after being deployed. This is to provide protection if the vehicle subsequently overturns or secondary collisions occur.

While Volkswagen passenger cars usually have one curtain airbag and gas generator on each side, for reasons of model variety in the Transporter from 2003 onward, for example, the curtain airbag is split into:

- Curtain airbag in the driver compartment
- Curtain airbag in the passenger compartment

This means it has two gas generators on each side.

Both the side and curtain airbags are deployed by the airbag control unit when a limit configured in it is reached. A side impact is detected by lateral acceleration sensors or pressure sensors in the doors.

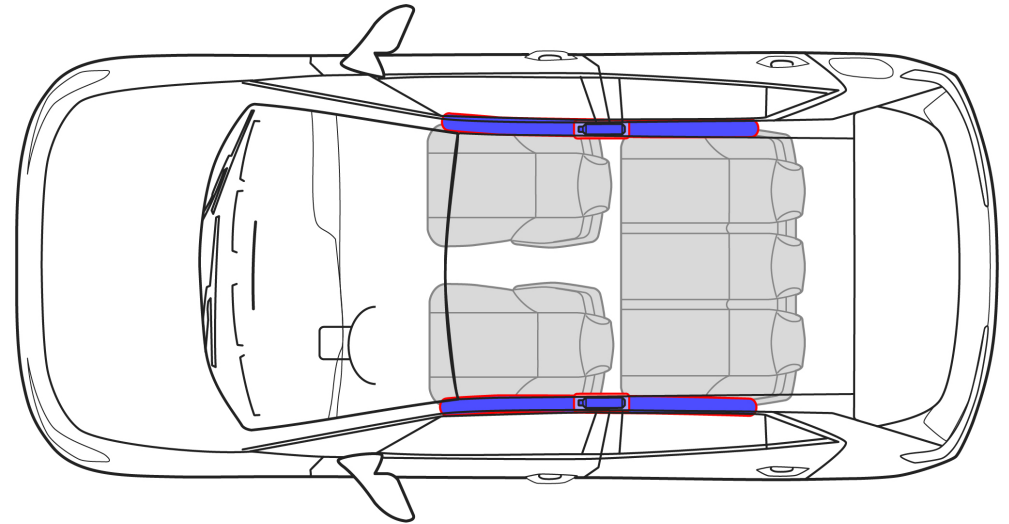

# Airbag gas generators

## Solid propellant gas generators

The solid propellant gas generators consist of a housing containing a solid propellant charge with an ignition unit. When the solid propellant is ignited, the airbag is filled with non-toxic gas.

### Function:

- The igniter is activated by the airbag control unit.
- The propellant charge is ignited and quickly combusts.
- The gas thus produced flows through the metal filter into the airbag.

## Hybrid gas generators

The hybrid gas generators consist of a housing containing a highly compressed gas, combined with a solid propellant charge and an ignition unit. The design and shape of the generator housing are adapted to the installation conditions. These generators are usually tubular.

The main components are the pressure vessel for the airbag inflation gas, and the (solid) propellant charge which is integrated in the pressure vessel or flange-mounted on it. Solid fuel in tablet or ring form is used. The stored compressed gas is a mixture of inert gases, for example argon and helium. Depending on the gas generator design, it is pressurised to between 200 bar and 600 bar.

When the solid propellant is ignited, it opens the pressure vessel, producing a gas mixture consisting of the solid propellant and the inert gas mixture.

### How it works:

- The igniter is activated by the airbag control unit and the propellant charge is ignited.
- This produces gas which breaks through rupture disc 1 and the pressure in the compressed gas cylinder increases until rupture disc 2 breaks.
- The gas mixture then flows out of the compressed gas cylinder through the metal filter and into the airbag.







Do not damage the gas generators during rescue work. The compressed gas in the pressure vessel and the pyrotechnic propellants may pose a hazard to the emergency services and the occupants.

## Belt tensioner

In the event of a crash, belt tensioners retract the belt in the opposite direction to which it is being pulled – this reduces slack (a gap between the belt and the body). This acts as soon as possible to prevent the occupant from being thrown forward (relative to the motion of the vehicle). A belt tensioner can retract the seat belt by up to 200 mm within 10 ms. If the counterforce acting on the seat belt is greater than the force of the belt tensioner, tensioning is ended.

The belt tensioners are integrated in the belt system. However, they may be installed in different locations depending on the type of vehicle (for example in the B-pillar, in the side member beside the seat or on the outside of the rear seat) and have different functional principles. In some cases, two belt tensioners may even be used on one seat.

	This means belt tensioners should not be damaged with rescue equipment if at all possible. Avoid hammering on this area.
	The belt also locks if the vehicle is at a steep angle, has overturned, or possibly if the belt tensioner has been damaged by the accident.
	Non-triggered belt tensioners with mechanical activation can still be triggered even after the battery is disconnected.
	If the situation allows, the seat belt should be taken off or cut off as soon as possible.
	Identification of belt tensioners as per ISO 17840

## Installation variants

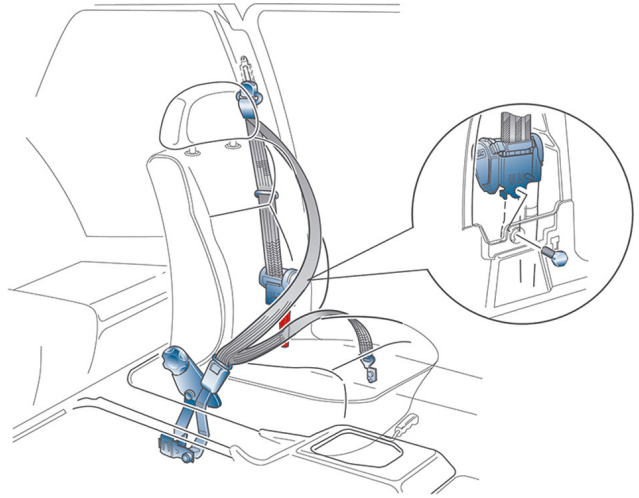
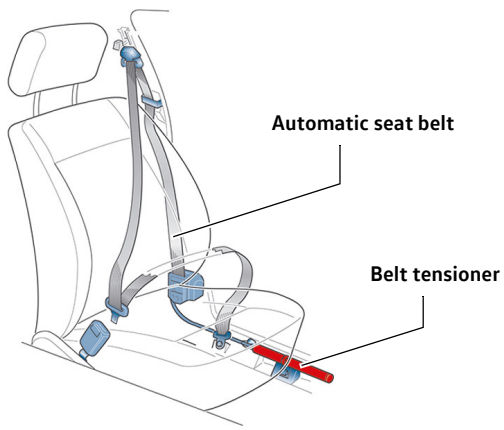
Variant	Location
	<p><b>Variant 1</b> The front automatic seat belt with the cylindrical belt tensioner and mechanical or electrical ignition trigger form a single unit and are installed either:</p> <ul style="list-style-type: none"><li>a) In the B-pillar below the belt retractor</li><li>b) As an external component next to the side member</li><li>c) In the B-pillar above the belt retractor.</li></ul> <p><b>Installation variant 1a – Belt tensioner in the B-pillar below the belt retractor</b></p>
	<p><b>Installation variant 1b – Belt tensioner as external component next to the side member</b></p>

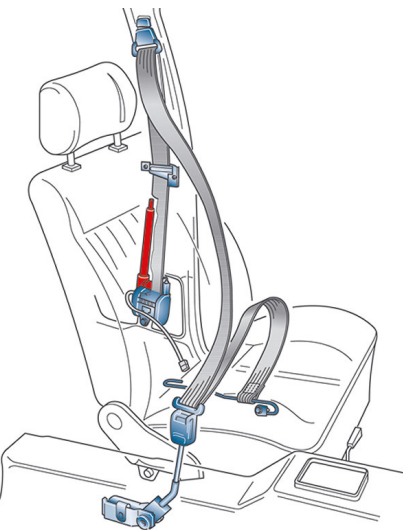
**Variant****Location**

**Installation variant 1c – Belt tensioner in the B-pillar above the belt retractor**

**Variant 2**

In the front compact tensioner, the automatic seat belt and belt tensioner with electric or mechanical ignition trigger form a single unit and are installed in the B-pillar.

**Installation variant 2 – Compact belt tensioner in the B-pillar**

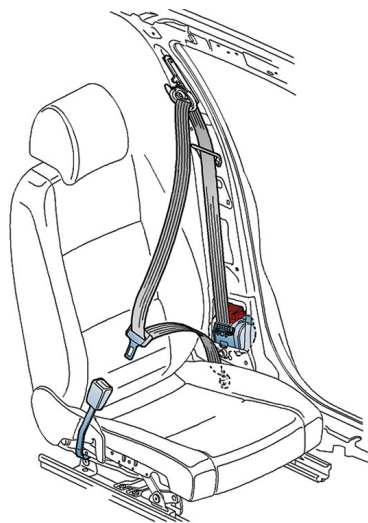

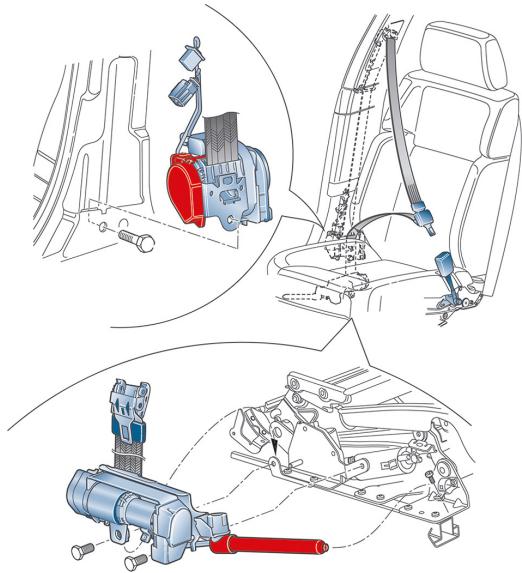
**Variant****Location****Variant 3**

In the front twin tensioner, the shoulder belt section with compact tensioner and the lap belt section with cylindrical tensioner form a functional unit.

The electric ignition trigger of the shoulder section is located in the B-pillar and the trigger for the lap belt section is on the seat frame.

**Installation variant 3 – Twin belt tensioner in the B-pillar and seat frame**

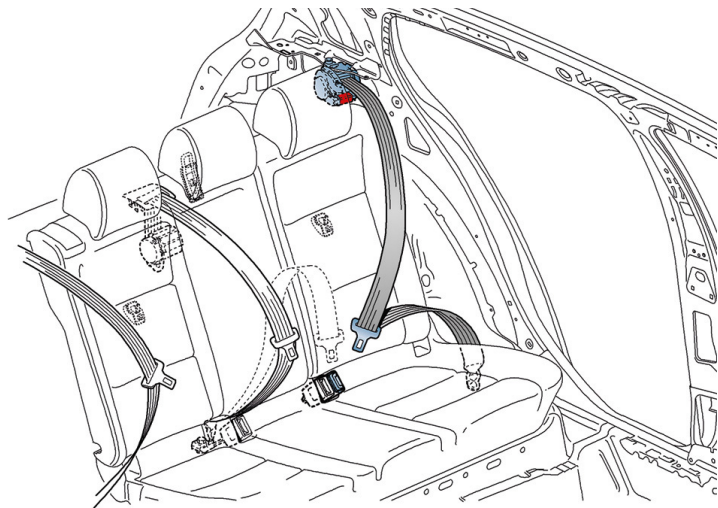
**Variant 4**

In the rear compact tensioner, the automatic seat belt and belt tensioner with electric or mechanical ignition trigger form a single unit and are installed behind the rear seat backrest.

**Installation variant 4 – Compact belt tensioner in the rear shelf**

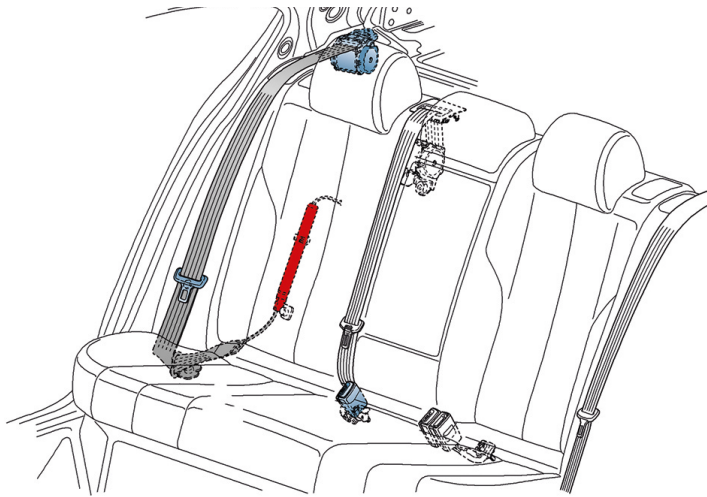

**Variant****Location****Variant 5**

Automatic belt and tensioner are arranged independently of each other. The belt tensioner with electric ignition trigger is installed in the wheel housing / C-pillar area.

**Installation variant 5 – Rear belt tensioner in the wheel housing / C-pillar area**

# Rollover bar

Convertibles must provide the greatest possible protection for occupants even when the roof is open. This is why a rollover protection system is used, which in combination with reinforced A-pillars provides a protective zone for the occupants. It can be rigid or dynamic.



A dynamic system functions as follows:

- The airbag control unit contains a sensor for detecting if the vehicle is about to roll over.

Together with other sensors in the control unit, the severity of the accident is determined and the rollover bar and belt tensioners are deployed.

The rollover bar is also deployed as a precaution in the event of a severe frontal, lateral or rear impact as soon as a belt tensioner or airbag is triggered.

It is deployed via a rollover bar trigger unit. A pre-tensioned spring moves the bar to the protective position within a quarter of a second, and it is locked in the extended position by a latching mechanism.

	<p>If the rear window is still intact when the rollover bar is triggered, the rollover bar will not break it. If the window is removed as part of the rescue operation, the rollover bar is pushed up a further 10 cm. It could hit rescue and recovery personnel and scatter glass shards.</p>
	<p>Identification of rollover bar as per ISO 17840</p>

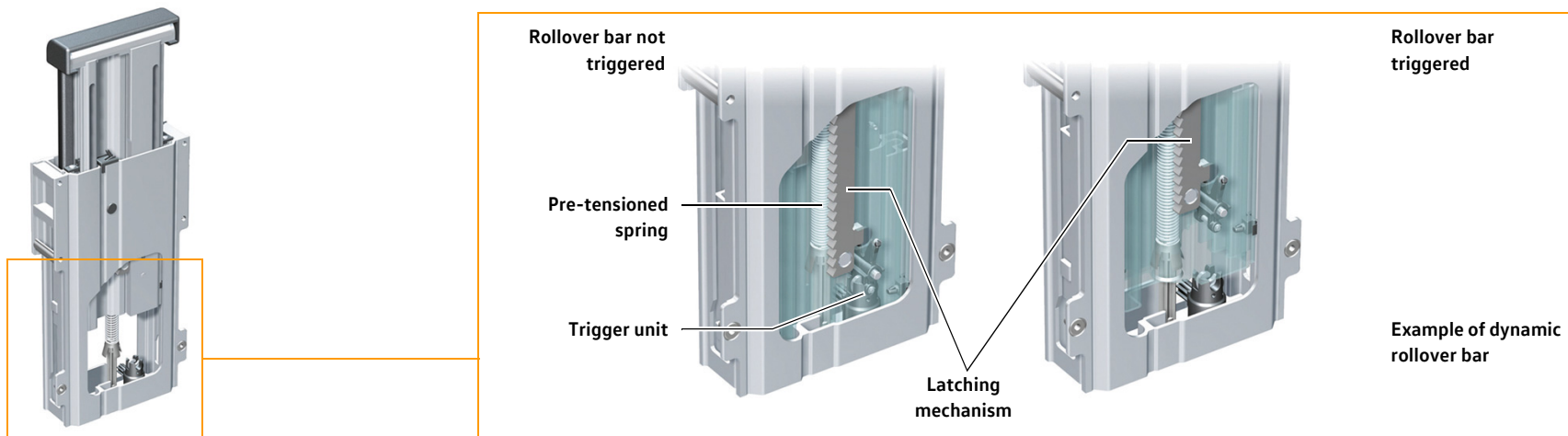



## Active bonnet

To ensure optimum protection for pedestrians, some Volkswagen vehicles are equipped with an active bonnet.

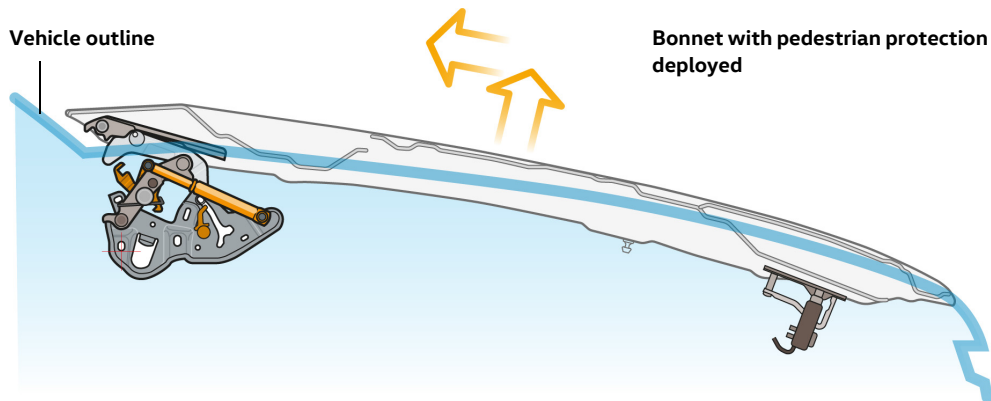
In the event of a collision with a pedestrian, the front and rear of the active bonnet are raised by pre-tensioned gas struts and pyrotechnic propellants. This increases the space between the bonnet and engine. The bonnet can absorb more impact energy in this position, thus reducing the risk of injury from the engine.



	Do not damage the gas generators during rescue work. The compressed gas in the pressure vessel and the pyrotechnic propellants may pose a hazard to the emergency services and the occupants.
	Indication of active bonnet as per ISO 17840

# **10. Explanation of pictograms used**

Components, functions and measures that have to be taken into account during a rescue operation are indicated by special pictograms.

The pictograms are used:

- Together with the illustration on the rescue card to show where the respective components/functions are located in the vehicle (for details, see ISO 17840-1 and ISO 17840-2)
- To indicate a particular function or danger; they can be used in the sections of the additional pages of the rescue card or the guide for emergency services
- To show how to identify the type of drive
- To indicate fire extinguishing measures.

Importance:

- 1 = Essential emergency information depending on the vehicle type/model;
- 2 = Optional information that further assists emergency measures.

The following tables list the pictograms used by Volkswagen for passenger cars and light commercial vehicles and the components and functions to be taken into account.

### Pictograms relevant to identification



#### Examples for identifying the drive type

Reference: ISO 17840-4

Importance: 1

Used for:

- Rescue card illustration
- Guide for emergency services, section 1

Note: Example pictograms for petrol and electric drive systems are shown here. See ISO 17840-4 for principles and other drive pictograms.

### Pictograms for access to components

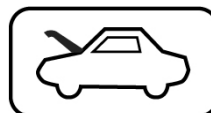

#### Title/meaning/reference: Bonnet

Function/description:

Identifies the control that opens the compartment outside the interior on the front of the vehicle. The pictogram may have a frame to distinguish it from the background.

Importance: 2

Used for:

- Rescue card illustration
- Guide for emergency services, section 3

## Pictograms for access to components

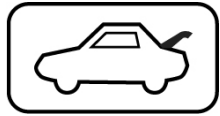

### Luggage compartment

Identifies the control that opens the compartment outside the interior on the rear of the vehicle. The pictogram may have a frame to distinguish it from the background.

Importance: 2

- Rescue card illustration
- Additional pages of the rescue card, section 3
- Guide for emergency services, section 3

## Pictograms for disabling a vehicle (without a high-voltage system)



### Apparatus for switching off the power sources in the vehicle

All power sources in the vehicle are switched off using:

- Ignition key
- Button
- Measure in the engine compartment
- Measure on the dash panel
- Battery switch
- Other measure

Importance: 1

- Rescue card illustration
- Additional pages of the rescue card, section 3
- Guide for emergency services, section 3

## Pictograms for disabling a vehicle (without a high-voltage system)

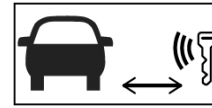

### Remove Keyless Access key.

Reminder to remove the Keyless Access key from the vehicle so that the engine is not accidentally started. Optionally, a safety distance may be specified.

Importance: 1

- Additional pages of the rescue card, section 3
- Guide for emergency services, section 3



### Air intake

Identifies the air intake that can be used to let in CO<sub>2</sub> in order to stop the engine.

Importance: 1

- Rescue card illustration
- Additional pages of the rescue card, section 3
- Guide for emergency services, section 3



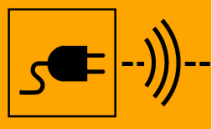
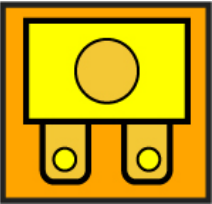

## Pictograms for disabling the high-voltage system of a vehicle (EV, HEV, PHEV, FCEV)

- Orange = high-voltage system (voltage class B)
- Yellow = control of the high-voltage system by the low-voltage system
- Orange frame = procedure for disabling the high-voltage vehicle

	<p><b>Hazardous voltage</b></p> <p>Indicates hazards caused by dangerous voltages.</p> <p>Importance: 1</p> <ul style="list-style-type: none"> <li>- Rescue card illustration</li> <li>- Additional pages of the rescue card, relevant sections as necessary</li> <li>- Guide for emergency services, relevant sections as necessary</li> </ul>
	<p><b>Vehicle with inductive charging system</b></p> <p>Indicates that the vehicle is connected to an electromagnetic induction source for charging the high-voltage traction batteries. Shows the location of the induction charging system and its components.</p> <p>Importance: 1</p> <ul style="list-style-type: none"> <li>- Rescue card illustration</li> <li>- Additional pages of the rescue card, section 3</li> <li>- Guide for emergency services, section 3</li> </ul>
	<p><b>Fuse socket for disabling the high-voltage system</b></p> <p>Identifies the low-voltage fuse that controls the high-voltage system.</p> <p>Importance: 1</p> <ul style="list-style-type: none"> <li>- Illustration and additional pages of the rescue card, section 3</li> <li>- Guide for emergency services, section 3</li> </ul>

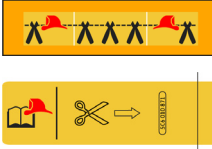
## Pictograms for disabling the high-voltage system of a vehicle (EV, HEV, PHEV, FCEV)

	<p><b>Cut cable</b></p> <p>Identifies which cable to cut in order to disconnect the high-voltage and SRS components from the power network. Indicates that the cable must be cut at two separate points. The size and proportions may be adapted to the purpose.</p> <p>Importance: 1</p> <ul style="list-style-type: none"> <li>- Illustration and additional pages of the rescue card, section 3</li> <li>- Guide for emergency services, section 3</li> </ul>
	<p><b>Apparatus for disconnecting the high-voltage system (e.g. maintenance connector)</b></p> <p>Identifies an apparatus that disconnects the high-voltage system, as well as the personal protective equipment (PPE) that may have to be used.</p> <p>Importance: 1</p> <p>Used for:</p> <ul style="list-style-type: none"> <li>- Rescue card illustration</li> <li>- Additional pages of the rescue card, section 3</li> <li>- Guide for emergency services, section 3</li> </ul>
	<p><b>Apparatus for disconnecting the high-voltage system</b></p> <p>Identifies the low-voltage device that disconnects the high-voltage system.</p> <p>Importance: 1</p> <ul style="list-style-type: none"> <li>- Rescue card illustration</li> <li>- Additional pages of the rescue card, section 3</li> <li>- Guide for emergency services, section 3</li> </ul>

## Pictograms for access to occupants



### Steering wheel inclination adjustment

Identifies the control for adjusting the steering wheel inclination up or down. The pictogram may have a frame to distinguish it from the background.

Importance: 2

- Guide for emergency services, section 4



### Seat height adjustment

Identifies the control for adjusting the seat height up or down. The pictogram may have a frame to distinguish it from the background.

Importance: 2

- Guide for emergency services, section 4



### Seat longitudinal adjustment

Identifies the control for moving the seat forward or back. The pictogram may have a frame to distinguish it from the background.

Importance: 2

- Guide for emergency services, section 4



### Lifting point, central support

Function/description: Identifies the points on the vehicle that are suitable for placing a jack or support.

Importance: 1

- Rescue card illustration
- Additional pages of the rescue card, section 2
- Guide for emergency services, section 2

## Other vehicle-related pictograms

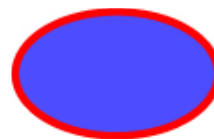

### Airbag

Function/description: Identifies an airbag.

Importance: 1

- Rescue card illustration
- Guide for emergency services, section 9

The pictogram can be modified to reflect the actual size and shape.

Various occupant protection systems with airbags can be displayed with the airbag pictogram in a corresponding size and shape, e.g.:

- Side airbag
- Curtain airbag
- Knee airbag
- Belt airbag



### Airbag gas generator

Identifies an airbag gas generator.

Importance: 1

- Rescue card illustration
- Guide for emergency services, section 9

The pictogram can be modified to reflect the actual size and shape.

The pictogram shows the location of a gas generator, e.g. for curtain airbags or active pedestrian protection systems.

This pictogram should not be used for conventional airbag systems with integrated gas generators, such as the front airbag in the steering wheel or dash panel, side airbags and knee airbag.

## Other vehicle-related pictograms

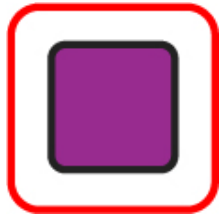

### Belt tensioner

Identifies a belt tensioner.

Importance: 1

- Rescue card illustration
- Guide for emergency services, section 9

If a seat has more than one belt tensioner (e.g. for hip and shoulder belts), all belt tensioner positions should be indicated with a pictogram.

The pictogram can be modified to reflect the actual size and shape.

A combination of simple forms can also be used.



### Gas strut / pre-tensioned spring

Identifies a gas strut.

Importance: 1

- Rescue card illustration
- Guide for emergency services, section 9

The red border is only used when the device is triggered. The pictogram can be modified to reflect the actual size and shape.



## Other vehicle-related pictograms



### Active pedestrian protection system

Identifies the active pedestrian protection system.

Importance: 1

- Rescue card illustration
- Guide for emergency services, section 9

The pictogram for active pedestrian protection systems is intended to indicate that the vehicle is equipped with a system that can be triggered (e.g. the bonnet).

The background of the pictogram is usually white, but alternatively the colour of the trigger mechanism may be used.

The pictogram can be combined with the trigger mechanism of the system (e.g. bonnet) or connected to it (airbag, gas generator, gas strut, pre-tensioned spring).



### High-strength area

Identifies a high-strength area.

Importance: 1

- Rescue card illustration
- Guide for emergency services, section 9

The pictogram can be modified to reflect the actual size and shape.

## Other vehicle-related pictograms

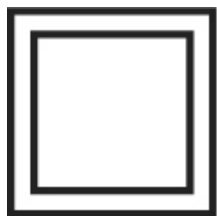

### Area requiring particular attention

Identifies the area to which particular attention should be paid.

Importance: 1

- Illustration and additional pages of the rescue card, section 5
- Guide for emergency services, section 5

The pictogram can be modified to reflect the actual size and shape.



### Carbon structure

Information that the vehicle body contains carbon. Indicates that there is a risk of inhalation and that appropriate PPE must be used.

Importance: 1

- Additional pages of the rescue card, section 5
- Guide for emergency services, section 5

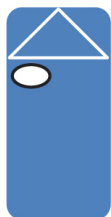

### Left-hand drive

Identifies a left-hand drive vehicle.

Importance: 1

- Rescue card illustration

For use in the header of the rescue card. The colour may be changed to stand out from the background of the header.

## Other vehicle-related pictograms



### Right-hand drive

Identifies a right-hand drive vehicle.

Importance: 1

- Rescue card illustration

For use in the header of the rescue card. The colour may be changed to stand out from the background of the header.

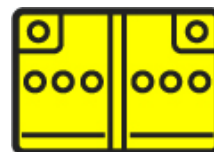

### Low-voltage battery

Identifies a low-voltage battery.

Importance: 1

- Rescue card illustration
- Additional pages of the rescue card, section 5
- Guide for emergency services, section 5

For class A live application. The battery technology should also be indicated (e.g. Li-Ion or NiMH) if it is not a conventional battery.

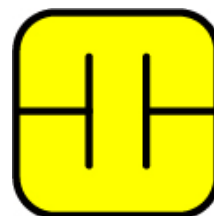

### Low-voltage supercapacitor

Identifies a low-voltage supercapacitor.

Importance: 1

- Rescue card illustration
- Additional pages of the rescue card, section 5
- Guide for emergency services, section 5

For class A live application.

## Other vehicle-related pictograms



### Solar cell

Identifies a solar cell.

Importance: 1

- Rescue card illustration
- Additional pages of the rescue card
- Guide for emergency services, section 3



### SRS control unit

Identifies an SRS control unit.

Importance: 1

- Rescue card illustration
- Guide for emergency services, section 9



### High-voltage battery

Identifies a high-voltage battery.

Importance: 1

- Rescue card illustration
- Additional pages of the rescue card, section 3
- Guide for emergency services, section 3

The pictogram can be modified to reflect the actual size and shape.

The battery technology should also be indicated (e.g. Li-Ion or NiMH).

Optionally, the rated voltage of the battery can be indicated.

## Other vehicle-related pictograms



### High-voltage supercapacitor

Identifies a high-voltage supercapacitor.

Importance: 1

- Rescue card illustration
- Additional pages of the rescue card, section 3
- Guide for emergency services, section 3

For class B live application.



### High-voltage component

Identifies a high-voltage component.

Importance: 1

- Rescue card illustration
- Additional pages of the rescue card, section 3
- Guide for emergency services, section 3

For class B live application.

The pictogram can be modified to reflect the actual size and shape. The lightning bolt may be omitted if there is not enough space.

## Other vehicle-related pictograms



### High-voltage cable

Identifies a high-voltage cable.

Importance: 1

- Rescue card illustration
- Guide for emergency services, section 3

For class B live application.  
The pictogram can be modified to reflect the actual shape and cable routing. A black frame may also optionally be used. It should be possible to distinguish high-voltage components from the high-voltage battery.  
The key and the pictogram graphics should match each other with regard to the line concept used for the frames.



### Diesel fuel tank capacity

Indicates the tank capacity with a defined colour.

Importance: 1

- Rescue card illustration
- Additional pages of the rescue card, section 5
- Guide for emergency services, section 5



### Petrol/ethanol fuel tank capacity

Indicates the tank capacity with a defined colour.

Importance: 1

- Rescue card illustration
- Additional pages of the rescue card, section 5
- Guide for emergency services, section 5

## Other vehicle-related pictograms



### Gas tank and type of gas (CNG)

Indicates the tank capacity with a defined colour and names the type of gas.

Importance: 1

- Rescue card illustration
- Additional pages of the rescue card, section 3
- Guide for emergency services, section 5



### Manual gas shut-off valve and type of gas (CNG)

Indicates the manual gas shut-off valve with a defined colour and names the type of gas.

Importance: 1

- Rescue card illustration
- Additional pages of the rescue card, section 3
- Guide for emergency services, section 3



### Automatic gas safety valve and type of gas (CNG)

Indicates the device that controls gas overpressure in a tank with a defined colour and names the type of gas.

Importance: 1

- Pressure-controlled (pressure relief device)
  - Temperature-controlled (temperature-controlled pressure relief device)
- Importance: 1
- Rescue card illustration
  - Additional pages of the rescue card, section 3
  - Guide for emergency services, section 3

## Other vehicle-related pictograms



### Gas tank and type of gas (LPG)

Indicates the tank capacity with a defined colour and names the type of gas.

Importance: 1

- Rescue card illustration
- Additional pages of the rescue card, section 3
- Guide for emergency services, section 5



### Manual gas shut-off valve and type of gas (LPG)

Indicates the manual gas shut-off valve with a defined colour and names the type of gas.

Importance: 1

- Rescue card illustration
- Additional pages of the rescue card, section 3
- Guide for emergency services, section 3



### Automatic gas safety valve and type of gas (LPG)

Indicates the device that controls gas overpressure in a tank with a defined colour and names the type of gas.

- Pressure-controlled (pressure relief device)
- Temperature-controlled (temperature-controlled pressure relief device)

Importance: 1

- Rescue card illustration
- Additional pages of the rescue card, section 3
- Guide for emergency services, section 3

## Other vehicle-related pictograms



### Compressed air tank

Identifies a compressed air tank.

Importance: 1

- Rescue card illustration
- Guide for emergency services, section 5



### Air conditioning component

Identifies an air conditioning component with a defined colour.

The coolant must be specified on the additional pages and the rescue card (e.g. CO<sub>2</sub>, fluorocarbon basis).

Importance: 1

- Rescue card illustration
- Additional pages of the rescue card, section 5
- Guide for emergency services, section 5

The pictogram can be modified to reflect the actual size and shape. The snowflake may be omitted if there is not enough space.



### Gas pipe (general)

Identifies a gas pipe with a defined colour.

Importance: 1

- Rescue card illustration
- Guide for emergency services, section 5

The pictogram can be modified to reflect the actual shape and pipe routing.



## Other vehicle-related pictograms

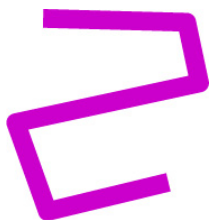

### Air conditioning pipe

Identifies an air conditioning pipe with a defined colour. The type or designation of the coolant must be identified (e.g. CO<sub>2</sub>, fluorocarbon basis).

Importance: 1

- Rescue card illustration
- Guide for emergency services, section 5

The pictogram can be modified to reflect the actual shape and pipe routing.

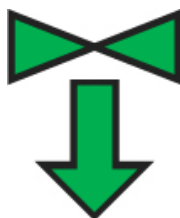

### Direction of the gas safety valve (e.g. LPG) in the vehicle

Indicates the direction of the gas safety valve in an illustration with a defined colour.

Importance: 1

- Rescue card illustration

## Pictograms for firefighting and safety



### General warning sign

Indicates a general warning.

Importance: 1

- Additional pages of the rescue card, corresponding sections as necessary
- Guide for emergency services, corresponding sections as necessary

## Pictograms for firefighting and safety

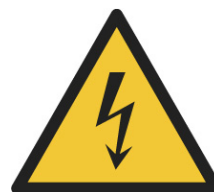

### Warning: electricity

Warns of electricity and dangerous voltage.

Importance: 1

- Additional pages of the rescue card, corresponding sections as necessary
- Guide for emergency services



### Warning: low temperature

Indicates hazards caused by low temperatures, e.g. frostbite from cold gases (e.g. LNG, air conditioning gas).

Importance: 1

- Additional pages of the rescue card, sections 5, 6 and 8
- Guide for emergency services, sections 5, 6, 8 and 9

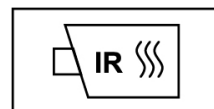

### Use thermal infrared camera

Indicates that a thermal infrared camera should be used to detect a fire.

Importance: 2

- Additional pages of the rescue card, section 6
- Guide for emergency services, section 6



### Automatic fire extinguisher system

Indicates that the vehicle has an automatic fire extinguisher system.

Importance: 1

- Rescue card illustration
- Additional pages of the rescue card, section 6
- Guide for emergency services, section 6

## Pictograms for firefighting and safety



### Special access to battery

Special access through which water can be poured into the high-voltage battery of an electric vehicle.

Importance: 1

- Additional pages of the rescue card, section 6
- Guide for emergency services, section 6



### Extinguish fire with water

Indicates that a fire must be extinguished with water.

Importance: 1

- Additional pages of the rescue card, section 6
- Guide for emergency services, section 6



### Extinguish fire with wet compressed air foam (CAF)

Indicates that a fire must be extinguished with wet compressed air foam. System in which foam and air are constantly mixed under pressure with the water from the fire extinguishing centrifugal pump (CAFS). When using wet compressed air foam, the nominal ratio of foam to air volume is 1:3 to 1:10 for mixture in the CAFS.

Importance: 1

- Additional pages of the rescue card, section 6
- Guide for emergency services, section 6

## Pictograms for firefighting and safety



### Extinguish fire with dry compressed air foam

Indicates that a fire must be extinguished with dry compressed air foam. System in which foam and air are constantly mixed under pressure with the water from the fire extinguishing centrifugal pump (CAFS). When using dry compressed air foam, the nominal ratio of foam to air volume is more than 1:10 for mixture in the CAFS.

Importance: 1

- Additional pages of the rescue card, section 6
- Guide for emergency services, section 6



### Extinguish fire with ABC powder

Function/description: Indicates that a fire must be extinguished with ABC powder.

Importance: 1

- Additional pages of the rescue card, section 6
- Guide for emergency services, section 6



### Do not extinguish with water

Prohibits the use of water to extinguish a fire.

Importance: 1

- Additional pages of the rescue card, section 6
- Guide for emergency services, section 6

## World-wide standard symbols



### Explosive

Indicates the risk of explosion.

Importance: 1

- Additional pages of the rescue card, sections 5, 6, 8 and 9
- Guide for emergency services, sections 5, 6, 8 and 9



### Flammable

Indicates danger due to flammability.

Importance: 1

- Additional pages of the rescue card, sections 5, 6, 8 and 9
- Guide for emergency services, sections 5, 6, 8 and 9



### Pressurised gases

Indicates danger due to pressurised gases.

Importance: 1

- Additional pages of the rescue card, sections 5, 6 and 8;
- Guide for emergency services, sections 5, 6, 8 and 9



### Oxidising

Indicates danger due to substances that intensify fire.

Importance: 1

- Additional pages of the rescue card, sections 5, 6 and 8;
- Guide for emergency services, sections 5, 6, 8 and 9

## World-wide standard symbols



### Corrosive

Indicates danger due to corrosive substances.

Importance: 1

- Rescue card illustration
- Additional pages of the rescue card, sections 5, 6 and 8;
- Guide for emergency services, sections 5, 6, 8 and 9



### Health hazard

Indicates a hazard to human health.

Importance: 1

- Rescue card illustration
- Additional pages of the rescue card, sections 5, 6 and 8;
- Guide for emergency services, sections 5, 6, 8 and 9



### Toxic

Indicates danger due to acute toxicity.

Importance: 1

- Rescue card illustration
- Additional pages of the rescue card, sections 5, 6 and 8;
- Guide for emergency services, sections 5, 6, 8 and 9

## World-wide standard symbols



### Environmental hazard

Indicates the risk of endangering the environment.

Importance: 1

- Rescue card illustration
- Additional pages of the rescue card, sections 5, 6 and 8
- Guide for emergency services, sections 5, 6, 8 and 9

## Symbols used in this guide



### Information

General information.